

CTX TEXTURE ANALYZER

Operating Instructions

Manual No. **M19-373**



INSTRUMENTATION & SPECIALTY CONTROLS DIVISION

11 Commerce Boulevard, Middleboro, MA 02302 USA
Tel: 508-946-6200 or 800-628-8139 (USA excluding MA)
Fax: 508-946-6262 Internet <http://www.brookfieldengineering.com>

Table of Contents

I. INTRODUCTION	5
I.1 Components	5
I.2 Utilities	6
I.3 Units.....	6
I.4 Specifications.....	7
I.5 Installation	8
I.6 Safety Symbols and Precautions.....	9
I.7 Key Functions.....	10
I.8 Cleaning.....	11
II. QUICK START GUIDE	12
III. OPERATION	14
III.1 Principle	14
III.2 Reset Button.....	14
III.3 Base Table	15
III.4 Probes.....	16
III.5 Fixtures	16
III.6 Operating Menu	16
III.7 Test Result Descriptions.....	18
III.8 Running A Test.....	19
III.8 Admin Functions.....	42
IV. TEST METHOD DEVELOPMENT.....	46
IV.1 Sample Preparation	46
IV.2 Test Probe / Fixture	46
IV.3 Test Parameters.....	47
IV.4 Recommendations	47
Appendix A - Probes, Fixtures, Calibration Accessories and Gelatin Accessories.....	48
Appendix B - Troubleshooting.....	61
Appendix C - Online Help and Additional Resources	62
Appendix D - Warranty and Repair Service	63

I. INTRODUCTION

CTX Texture Analyzer is a newly designed instrument which incorporates modern touch-screen user interface and graphical display in standalone mode. Important features for maximum flexibility of use include choice of interchangeable load cell from 100g to 100kg, extended beam travel distance to 280mm (11 inches), and selectable data output rate with maximum at 500Hz.

Control of CTX by PC is also possible using new Texture Pro Software which gives users the capability to compare test data from multiple runs for repeatability. The user also has the ability to create custom test methods. An advanced version of the software provides full support for 21CFR Part 11 requirements on user access and data integrity.

CTX design is totally new based on extensive input from users of Brookfield’s popular CT3 Texture Analyzer. State-of -the-art electronics and modern display screen technology are essential elements in providing an effective user-friendly instrument for both R&D as well as QC. Rapid test set up and execution have natural appeal to all levels of users.

Principle of operation is to subject test sample material to controlled forces in compression or tension mode using Brookfield probes and fixtures already well established in the texture analysis market. The resistance of the material to these forces is measured by a calibrated load cell and shown in either grams or newtons. These measurements can be compared with human sensory panel data to establish physical test methods used in Quality Control for foods, cosmetics, pharmaceuticals, packaging materials and many others.

The main objective is to characterize your sample in a way that best represents their perception by human senses. This is the essence of texture analysis.

There are eight load cell ranges available for the CTX Texture Analyzer:

<u>Part Number</u>	<u>Load Cell Range</u>
CTX001	0.1kg or 100g
CTX010	1.0kg or 1000g
CTX015	1.5kg or 1500g
CTX050	5kg or 5000g
CTX100	10kg
CTX250	25kg
CTX500	50kg
CTX01K	100kg

I.1 Components

Please check to be sure that you have received all components, and that there is no damage. If you are missing any parts, please notify AMETEK Brookfield or your local authorized dealer immediately. Any shipping damage must be reported to the carrier.

<u>Component</u>	<u>Part Number</u>	<u>Quantity</u>
CTX Texture Analyzer	varies	1
Quick Start Guide & Unpacking Guide	T18-1046 / T18-1047	1ea.

The operator’s manual and other documents
can be downloaded here.



<u>Component</u>	<u>Part Number</u>	<u>Quantity</u>
USB Cable for PC Interface	DVP-202	1
Power Cord, 115/230 volts	varies	1
Probe Adapter M6 to M3 Threads	TA51	1

Optional Items:

<u>Component</u>	<u>Part Number</u>	<u>Quantity</u>
Load Cell	varies	1
Probes/Fixtures	varies	per order
Temperature Probe	TA-TEMP	1
Rotary Base Table	TA-RT-KIT	1
Fixture Base Table	TA-BT-KIT	1
Bloom Strip	CT3-CS-100 <i>or</i> CT3-CS-1000	1
Calibration Weight Set	varies by load cell	1
Standard Probe Kit	TA-P-KIT2	1
Texture Pro Software Standard	SWL-02-111	1
Texture Pro Software Advanced	SWL-02-211	1

NOTE: See Appendix A for details on probes and fixtures.

I.2 Utilities

Input Voltage:	90-265 VAC
Input Frequency:	50/60 Hz
Power Consumption:	150 VA
Fuse:	Two 4 amp, 5 x 20mm, Time-lag

Main supply voltage fluctuations are not to exceed $\pm 10\%$ of the nominal supply voltage.

I.3 Units

The CTX Texture Analyzer uses the SI system of units for all parameters.

<u>Parameter</u>	<u>Unit</u>	<u>Abbreviation</u>
Load	Grams or Newtons	g or N
Deformation	Millimeter	mm
Time	Seconds	s
Speed	Millimeter per second	mm/s
Work	MilliJoules	mJ

I.4 Specifications

Load:

<u>Load Cell</u>	<u>Range</u> <u>Grams</u>	<u>Resolution</u> <u>Grams</u>	<u>Accuracy*</u>
CTX001	0-100	0.01	±0.2% FSR
CTX010	0-1000	0.1	±0.2% FSR
CTX015	0-1500	0.1	±0.2% FSR
CTX050	0-5000	0.1	±0.2% FSR
CTX100	1-10000	0.1	±0.2% FSR
CTX250	2-25000	1.0	±0.2% FSR
CTX500	5-50000	1.0	±0.2% FSR
CTX01K	10-100000	1.0	±0.2% FSR

FSR = Full Scale Range

*Accuracy is 0.2% FSR, when the instrument is operated in a stable ambient temperature (20°C - 25°C).

Trigger Point:

<u>Load Cell</u>	<u>Range</u> <u>Grams</u>	<u>Resolution</u> <u>Grams</u>
CTX001	0 - 10	0.01
CTX010	0 - 100	0.1
CTX015	0 - 150	0.1
CTX050	0 - 500	0.1
CTX100	0 - 1000	0.1
CTX250	0 - 2500	1.0
CTX500	0 - 5000	1.0
CTX01K	0- 10000	1.0

Recommended minimum trigger value settings are given in Table III.1.

NOTE: Setting a trigger value of zero disables the trigger function, so test will immediately start from the current position.

Speed: 0.01 to 0.1mm/s in increments of 0.01mm/s
0.1 to 40mm/s in increments of 0.1mm/s*
Accuracy: ±0.1% of set speed

* Maximum test speed for 100kg = 10mm/s and 50kg = 20mm/s

Position: Range: 0-280mm
Resolution: 0.0005mm
Accuracy: 0.1mm

Increments for changing test speed using the arrow buttons are switched from 0.1mm/s to 1.0mm/s when entering speeds above 10mm/s.

Temperature Sensing Range: -20°C to 120°C (Requires optional temperature probe, TA-TEMP)

Interface: (3) USB A, (1) USB B, GPIO

Environmental: 0°C to 40°C temperature range (41°F to 104°F)

Conditions: 20% - 80% relative humidity, non-condensing atmosphere

Use: Intended for indoor use only

Altitude: up to 2000m

Dimensions: 10.5" x 16" x 25"

Weight: 50lbs. (22.7kg)

I.5 Installation

- 1) Prepare a clean, level surface.

NOTE: This instrument is a sensitive force measuring device. It should be installed on a clean, solid, level bench surface which is free from external vibrations.

- 2) Unpack and remove the CTX Texture Analyzer from the shipping container.

 The CTX Texture Analyzer weighs 22.7 kg (50 pounds). Cautiously use two people when lifting the unit out of the packaging.

- 3) Place the CTX Texture Analyzer on a sturdy, level surface. Adjust the four feet to ensure that the instrument is stable.

- 4) Remove any additional components from the shipping package. Save the shipping container and packaging for future use.

- 5) Install base table using the supplied pair of T-bolts and thumbnuts. Position the base table so that it is approximately centered under the probe. More accurate alignment may be required for certain fixtures.

- 6) Make sure that the AC power switch at the rear of the CTX Texture Analyzer is in the OFF position. Connect the power cord to the socket on the back panel of the instrument and plug it into the appropriate AC line. Position instrument so that the power cord can be removed easily.

 The AC input voltage and frequency must be within the appropriate range as shown on the model and serial tag of the instrument (located on the back of the CTX).

 The CTX Texture Analyzer must be earth grounded to ensure against electronic failure!

- 7) If appropriate, connect the USB computer controller cable to the appropriate port for connection to a computer.

- 8) Turn the power switch to the ON position. The About screen will indicate the part number, serial number, firmware version and load cell installed in the CTX (Figure I.1).

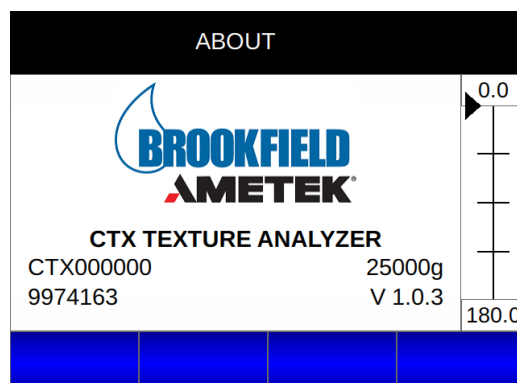

Figure I.1

- 9) If desired, check calibration according to Section III.11.

I.6 Safety Symbols and Precautions

Safety Symbols

The following explains safety symbols which may be found in this operating manual, or on the instrument itself.



Indicates hazardous voltages may be present.



Refer to the manual in all cases where this symbol is evident. Used for specific warning or caution information to avoid personal injury or damage to the instrument.



Keep hands, fingers and other body parts clear of moving parts when operating instrument.



Functional Earth Terminal - Main power entry module must have an earth conductor.

Precautions



If this instrument is used in a manner not specified by the manufacturer, the protection provided by the instrument may be impaired.



This instrument is not intended for use in a potentially hazardous environment.



In case of emergency, turn off the instrument and then disconnect the electrical cord from the wall outlet.



The user should ensure that the substances placed under test do not release poisonous, toxic or flammable gases or liquids at the temperatures which they are subjected to during the testing.

I.7 Key Functions

The CTX Texture Analyzer is operated through a touch screen and keypad (Start/Stop, Adjust Beams, and Up/Down arrows). The red Reset button with directional rotation arrows is located below the touch screen to the left side.

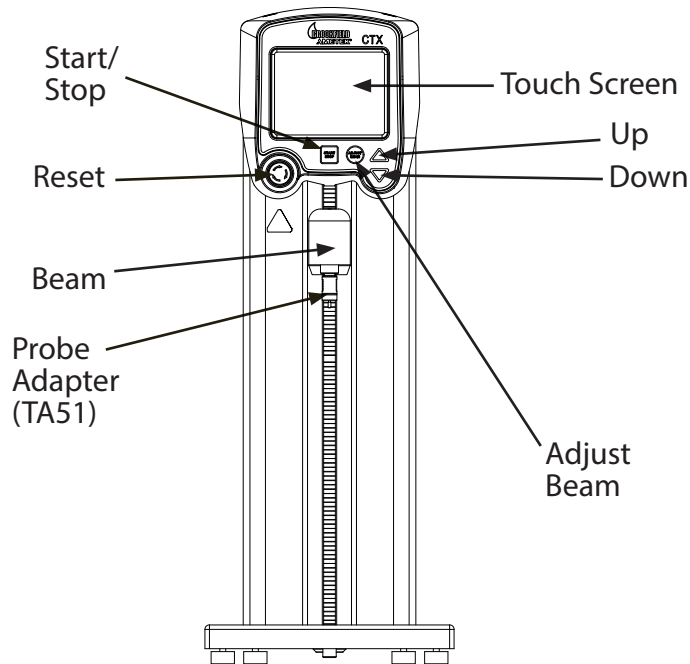

Figure I.2



START / STOP

Use the “Start/Stop” key to start a test, or stop an already running test.



ADJUST BEAM

Used to set the height of the beam via manual or auto modes of operation; also used to set top and bottom limits for beam position.



UP/DOWN ARROWS

The up and down arrow keys are used to scroll through numerical values and through choices/options for various features.

Press and hold key for 1.5 seconds will start fast scroll, automatically switching from the smallest increment at first, then to the next increment until at the highest increment; scroll rate for options is 4 per second.



RESET

Used to stop the test; upon release, the adjust beam screen can be used to move the beam back to the required position for start of a new test.

BACK PANEL

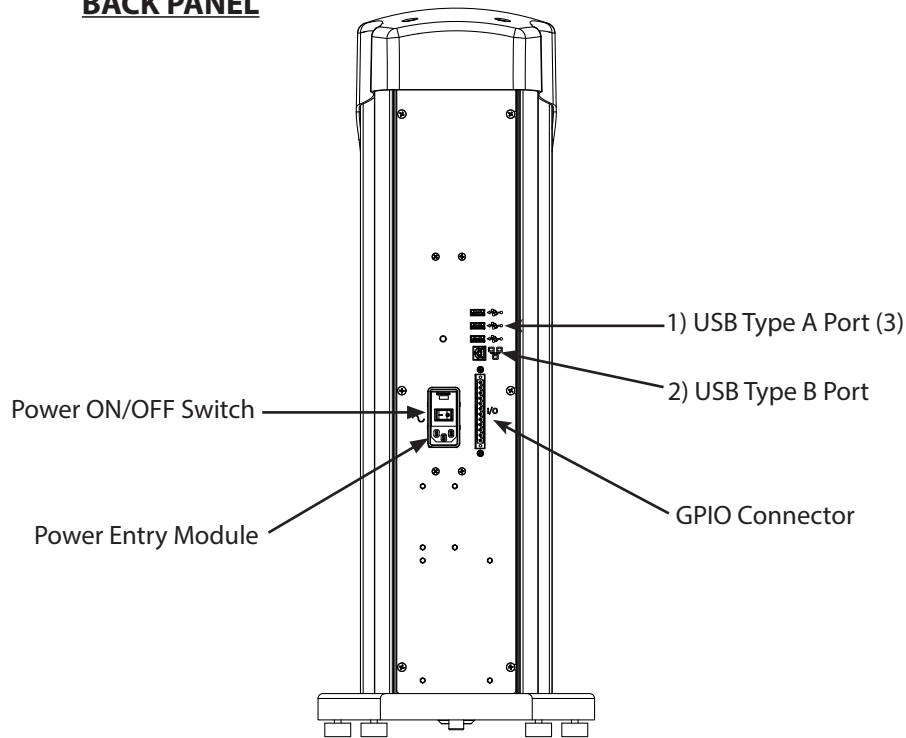

Figure I.3

- 1) USB TYPE A PORT (3); Optional Temperature Probe (TA-TEMP) has Type A connector; Optional Dymo Label Printer (GV-1050)
- 2) USB TYPE B PORT: Use with USB Cable P/N DVP-202 to connect instrument to a computer. Cable USB 2.0 A Male to B Male. See Appendix D, (CTX for External Mode).
- 3) GPIO Connection 12 Pin
- 4) Power Entry Module: ON/OFF switch-fused (see I.2 Utilities). Voltage: 90-265 VAC.

NOTE: Your CTX is an electronic instrument with a microprocessor similar to a computer. It is recommended that you perform a power cycle on your instrument at least once per week. When power cycling, always remember to save your data.

I.8 Cleaning

Instrument and Keypad:

Clean with a dry, nonabrasive cloth. Do not use solvents or cleaners.

Probes and Fixtures:

Probes and fixtures are made from a variety of materials from metals (stainless steel, aluminum) to plastics (acrylic, Black Delrin, Nylon). Clean with a nonabrasive cloth using solvents that are appropriate for both the sample material and the material of the probe and/or fixture.



Do not apply excessive upward, downward or sideways force to probe while fixed to CTX. Damage may occur to the load cell.

II. QUICK START GUIDE

1. Unpack the instrument. For more information, see the unpacking instructions.
2. If load cell is in carrying case, remove and insert under the beam cavity, plug in the USB and secure the load cell with the Allen wrench provided (found in the case with the load cell(s)).

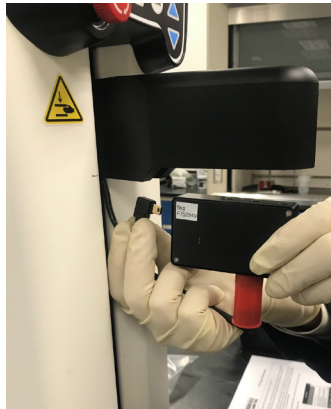

Figure II.1

3. If purchased, install the base table in accordance with the instruction sheet that is enclosed with the table.
4. Plug in the power cord and turn on the instrument.
5. Next, adjust the beam to the desired height by selecting the “adjust beam” button next to “start/stop” on the front panel. Use the Up/Down arrows to adjust the beam to the desired height. Then, press the back button.

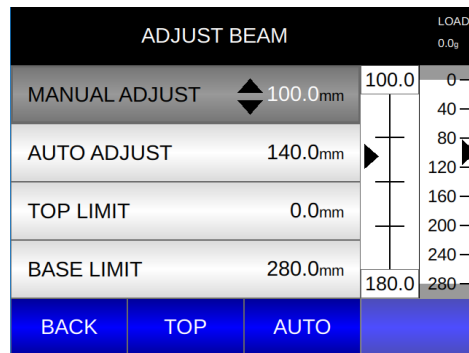

Figure II.2

6. Remove the cap from the load cell and attach the selected probe. Refer to Appendix A for more information.

7. Select Configure test.

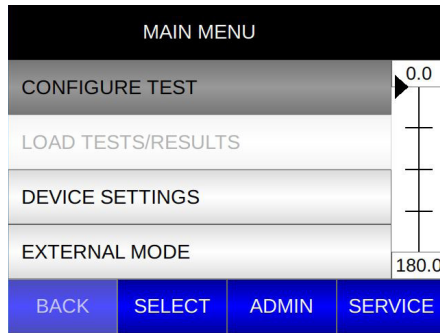

Figure II.3

8. Select the desired test.

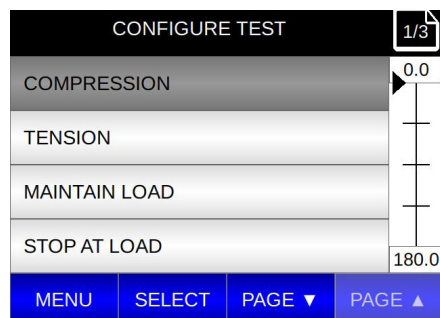

Figure II.4

9. Set the test parameters. Refer to Section III.6: Operating Menu for more information.

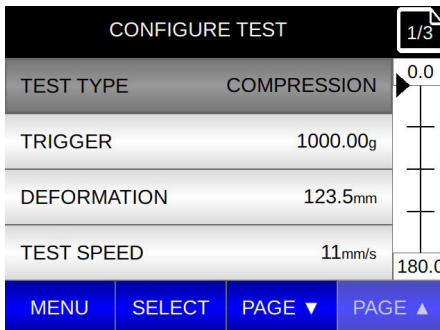

Figure II.5

10. The instrument is ready for testing, press the START/STOP to begin.

III. OPERATION

III.1 Principle

The Brookfield CTX Texture Analyzer can be operated in either compression or tension modes.

In compression mode, a probe moves down slowly at pretest speed until a threshold value (the trigger) is reached. The probe then moves a set distance at a set speed into the sample material that is placed (or fixed) on the base table. The load is continuously monitored as a function of both time and distance until the probe again returns to its starting position.

In tension mode, the sample is typically held between a pair of grips. The test starts when the trigger load is reached as the grips move apart. As stretched or pulled apart, the measurement load is recorded as a function of both time and distance.

III.2 Reset Button

The CTX Texture Analyzer can operate with up to 100 kg of force dependent on load cell in use. The probe may start moving automatically without warning, on certain test sequences. Be sure to place only the sample for test under the probe.



Keep body parts and clothing away from the probe during the test.

The user must take care not to place any body part or clothing in the testing zone while the machine is moving. The CTX Texture Analyzer is provided with a Reset Button (see Figure I.2) for use in case of an operational problem.

Depressing the Reset Button during a test will:

- 1) Stop the test in progress and display an error message as shown in Figure III.1.

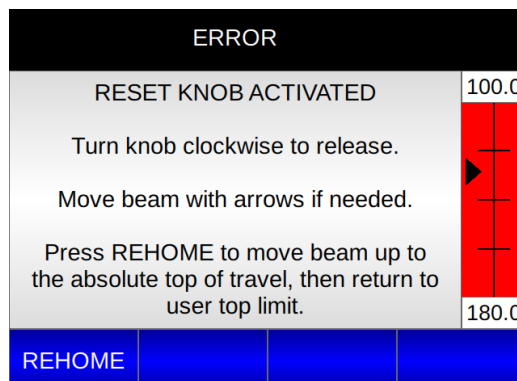

Figure III.1

- 2) The Reset condition can be canceled by rotating the Reset Button clockwise. An additional REHOME button will appear on the touch screen, this button will reset the instrument and the beam will move to the home position. This will reset the CTX firmware to the power up condition.

III.3 Base Table

The CTX Texture Analyzer has three options for Tables on which the test sample is placed. The tables should be secured to the slotted base of the CTX with thumb-nuts and T-bolts. This design provides ample adjustment side-to-side and front-to-back to correctly align fixtures and position a wide range of samples for testing.

NOTE: Always be sure all position and height adjustments are securely locked before starting every test.

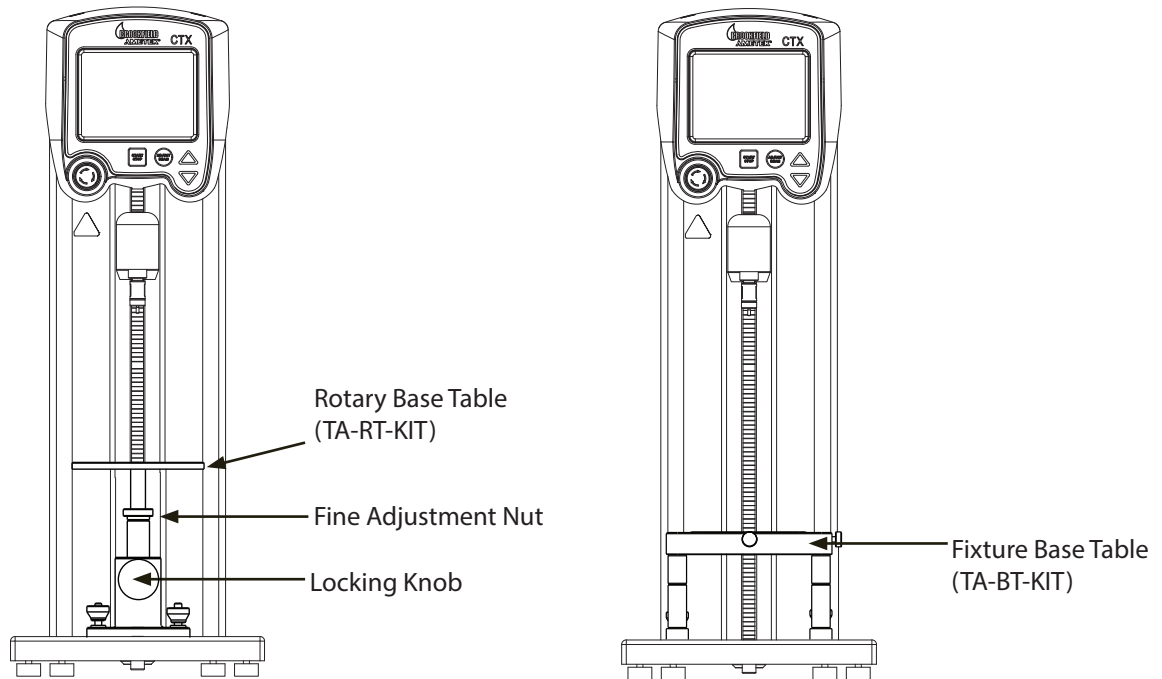

Figure III.2

See Appendix A for fixtures which can be used with each Table.

Rotary Base Table

The Rotary Base Table (P/N TA-RT-KIT) is a disc shaped surface and should always be centered under the probe when conducting compression tests. There are two methods of adjusting the height in order to place the sample close to the probe for testing. The locking knob on the base of the Rotary Table allows quick height adjustment; just unlock the knob, raise or lower the table, then lock it into position. The table is also mounted on a threaded shaft held securely with a fine adjustment nut. Unlocking the fine adjustment nut and rotating the table will raise or lower the test surface to give even more range to the height adjustment.



Always hold the Rotary Base Table firmly with one hand while loosening the Locking Knob. This will prevent the Rotary Base Table from dropping abruptly.



Keep fingers away from the Fine Adjust Nut when lowering the Rotary Base Table to prevent a pinch injury.

Fixture Base Table

The Fixture Base Table (P/N TA-BT-KIT) is a rectangular test surface with a removable center. Many of the test fixtures fit into this center area so this table becomes the mounting base for these sample test fixtures. The Fixture Base Table is supplied with a variety of extension legs to set the

test surface at the correct height for all accessory fixtures. Some disassembly is required to add or remove extension legs by loosening the Phillips head bolts in the underside of the base table.

Adjustable Base Table

The Adjustable Base Table (P/N TA-ABT) is a convenient table to use when testing samples that require frequent adjustment to table height.

III.4 Probes

There are a wide range of probes available for use with the CTX Texture Analyzer as described in Appendix A. One should always be aware that the probe chosen will have an impact upon the test result. Choice of a probe must be made with consideration toward the purpose of the test and the nature of the sample.

The probes may be cleaned while attached to the CTX. Follow recommendations in Section I.8.



Always attach probes only finger tight to prevent thread damage. Do not apply excessive upward, downward or sideways force. Damage may occur to the load cell.

Inspect a probe before use for any damage. Always handle the probes carefully as some have sharp points or edges. Most probes require the TA51 thread adapter to attach to the CTX. Keep it in a safe place as it is needed for most probes.

III.5 Fixtures

There are a range of fixtures available for use with the CTX Texture Analyzer as described in Appendix A. These devices are designed to hold a sample in place during measurement. Each fixture is designed to attach to one of the base tables. Refer to the instructions provided with the fixture for proper installation.

NOTE: Brookfield can design custom fixtures for your application. Contact AMETEK Brookfield or your local authorized dealer for details.

III.6 Operating Menu

The CTX Texture Analyzer offers nine test modes, one load calibration check mode and one beam travel distance check mode. Descriptions of these modes are as follows:

Test Mode	Description	
Compression	Single compression cycle	
Tension	Pulls apart a sample using tensile force	
Maintain Load	Applies and maintains constant force on a sample as it relaxes	
Stop at Load	Applies force on a sample until it reaches the set target load	
Rupture	Applies force on to a sample until sample ruptures	
Bloom	Compression test measures gelatin bloom strength	Requires 100g, 1000g, 1500g or 5000g load cell
Surimi	Specific rupture test on Surimi samples	
TPA	Two cycle Texture Profile Analysis compression test	
Tack	Adhesive test on sample substrate	
Static Load	Load calibration check using certified weights	
Travel Check	Distance calibration check, using gauge blocks	

Each test mode requires parameters to be set. The specific parameters required will depend upon the type of test chosen:

Test Mode	Required Parameters			
Compression	Trigger	Deformation	Speed	
Tension	Trigger	Deformation	Speed	
Maintain Load	Hold Time	Trigger	Target Load	Material Coefficient
Stop at Load	Trigger	Target Load	Hold Time	Speed
Rupture	Trigger	Correction Factor	Speed	
Bloom	All parameters are fixed according to industry standard			
Surimi	Trigger	Correction Factor	Speed	
TPA	Trigger	Deformation	Speed	
Tack	Trigger	Target Load	Hold Time	Speed
Static Load	None			
Travel Check	None			

These parameters, once set, will be maintained by the CTX even after power down to facilitate repetitive testing. The test mode used prior to powering down will be presented when the test is selected again from configuration. A test is started by depressing the start/stop button. The test parameters are defined as follows:

- Trigger:** The load, in grams, measured by the CTX to indicate that the probe is in contact with the sample. Once the trigger value is reached, the test will begin at the defined speed. Brookfield recommends trigger values as specified in Table III.1.
- Deformation:** The total downward distance the probe will travel once the trigger value is reached.
- Speed:** The speed at which the probe will travel the specified distance. (Pre/test/Post)
- Hold Time:** The number of seconds that the probe will be held at the defined distance during a Hold Time test.
- Cycle Count:** The number of cycles (Speed and Distance) that will be applied to the sample during a Cycle Count test.
- Correction Factor:** Specifies the size of the load drop, in grams, that is required to recognize a gel rupture. The correction value is based on Load Cell. The low value is equal to the resolution of the load cell and the high resolution is equal to the max trigger setting of the load cell.
- Material Coefficient:** Used to describe material characteristics. Harder materials corresponds to smaller material coefficient and softer materials corresponds to larger material coefficient.

All parameters can be set within the ranges shown in Table III.1.

Load Cell Range								
Parameter	100g	1000g	1500g	5000g	10kg	25kg	50kg	100kg
Trigger*	0.5 - 10g	0.5 - 100g	0.2 - 150g	0.5 - 500g	1 - 1000g	2 - 2500g	5 - 5000g	5 - 10000g
Deformation (mm)	0.1 - 280	0.1 - 280	0.1 - 280	0.1 - 280	0.1 - 280	0.1 - 280	0.1 - 280	0.1 - 280
Speed (mm/s)	0.01 - 40	0.01 - 40	0.01 - 40	0.01 - 40	0.01 - 40	0.01 - 40	0.01 - 20	0.01 - 10
Hold Time	0 - 3600s	0 - 3600s	0 - 3600s	0 - 3600s	0 - 3600s	0 - 3600s	0 - 3600s	0 - 3600s
Cycle Count	0 - 10	0 - 10	0 - 10	0 - 10	0 - 10	0 - 10	0 - 10	0 - 10
Correction	0.1 - 10	0.1 - 100	0.1 - 150	0.1 - 500	0.1 - 1000	1 - 2500	1 - 5000	1 - 10000
Material Coefficient	0 - 20	0 - 20	0 - 20	0 - 20	0 - 20	0 - 20	0 - 20	0 - 20

Table III.1

Define a test by first selecting configure test. Use the touch screen and arrow buttons until the desired test mode is displayed, then press the test or use the select button. As the tests are displayed, the parameters specific to that mode will be shown with the previously selected parameters.

Display Conventions

The CTX display contains a touch screen and keypad for ease of operation.



Figure III.3

III.7 Test Result Descriptions

Peak Load:	Reported as the maximum measured load during the test.
Deformation @ Peak:	The distance to which the sample was compressed or pulled apart when the peak load occurred.
Work :	Defined as the energy required to deform or pull apart a sample. It is calculated by integrating the force vs. distance to compress or pull apart the sample. Work done is reported in millijoules.
Final Load:	The load reached at the set deformation. Often the peak load and final load will be the same value.
Temperature:	Recorded in °C or °F provided that the optional temperature probe, TA-TEMP, is connected to the CTX.
Adhesiveness and Adhesive Force:	The values measured as the energy and force required to separate a probe from the sample on the return stroke.
Peak Mean Load:	The average peak load during multi cycle test.
Peak Standard Deviation:	One standard deviation of the peaks during multi cycle test.
Deformation @ Start:	The amount of deformation once the target load is reached, during maintain load test.
Deformation @ End:	The amount of deformation at the end of the test, during maintain load test.
Creep Deformation:	Difference between deformation at start and deformation at end, during maintain load test.
Deformation @ Rupture:	The distance to which the sample was compressed when the rupture occurred.
Rupture Load:	The peak load at rupture.

III.8 Running A Test

A test is initiated by depressing the start button. Before proceeding, adjust the probe position as needed.

The probe can be moved downwards or upwards by selecting the ADJUST BEAM button. When selecting the MANUAL ADJUST, the beam can be moved with the up and down arrows by 1mm per key press or by depressing the up or down arrow continuously moves the probe at a constant speed of 10mm/s to the desired position.

The operator can change the speed of the probe adjustment in the Admin screen.

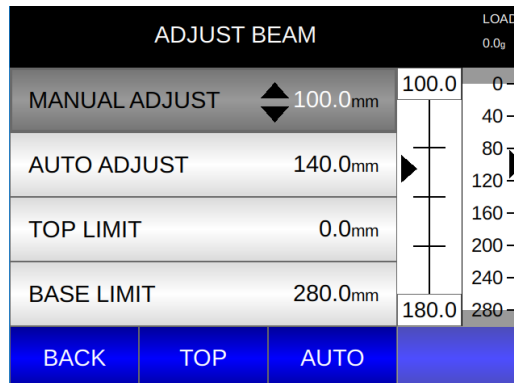

Figure III.4

AUTO ADJUST is used to position the probe quickly at the height near your sample. Use the Edit key to enter the desired position; choices range from 0mm, where the beam is in the top position, to 280mm, where the beam is at the bottom position. Press ENTER to save the setting, and then press AUTO. Note the scale on the far right of the screen, which shows the absolute position (0 - 280mm), with the triangle indicating the beam position. The CTX will move the beam to the height saved.

TOP LIMIT and BASE LIMIT can also be set using the up and down arrows or the EDIT key to set the locations. See Figure III.4 that shows 100.0mm for the TOP LIMIT and 180.0mm for the BASE LIMIT. Note that the inner scale shows the relative position from the beam to the top and base limit.

Proceed to run the test by pressing the START button.

At the completion of the test, the results will be displayed until the start button or reset button is pressed. The reset button will return the instrument to the default display where the test mode may be selected. The start button will begin the same test again.

A test may be repeated simply by depressing the start button while viewing test results.

The test may be stopped at any time by using the stop/reset button.

It may happen that the instrument overloads during a test. This will happen if the load exceeds 110% of the load cell capacity. When an overload condition occurs the display will show the following:

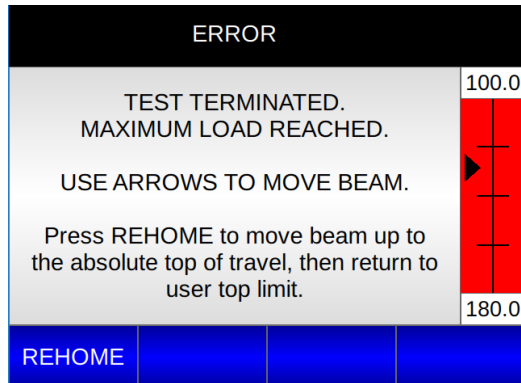

Figure III.5

Depressing the REHOME button will move the beam up to the absolute top of travel, then move it to the user top limit and return to the test mode menu. Correct the reason for the overload and retest.

COMPRESSION TEST – performs a single or series of compression(s) of the sample, then immediately returns to HOME starting position.

The operator sets the trigger value, deformation (travel distance into the sample) and the test speed using the Compression Test Type screen:

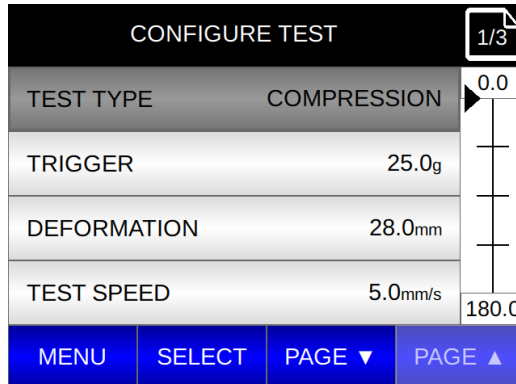

Figure III.6

Additional test parameter choices can also be added by using the Page down option: Hold time, Cycle Count, Pre-test and Post-test speeds.

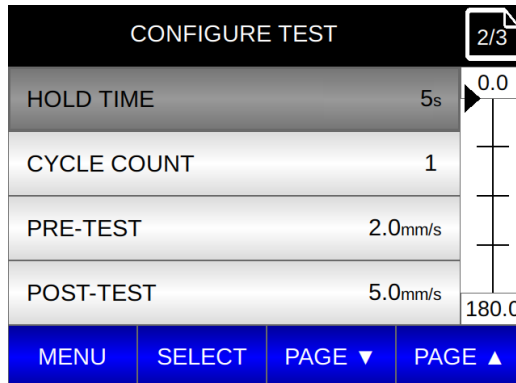

Figure III.7

One more page down will allow you to set the QC limits for acceptable values: QC Load Low, QC Load High:

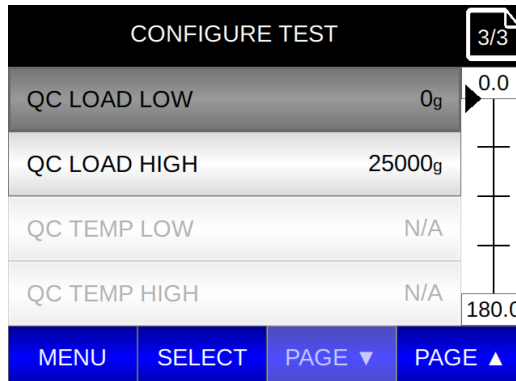

Figure III.8

Compression test performs a compression cycle when the operator depresses the start button. After the trigger load is reached, the probe descends at the programmed test speed to the target deformation, then returns immediately to home/starting position. If Hold Time is set to a value other than 0, the probe will remain in place at the target deformation distance while the timer counts down to 0. If Cycle Count is added, the test will be performed as many times as indicated. After the completion of the test, the return travel speed can be set from 0 - 40mm/s, dependent on load cell.

During the test, after the trigger load has been reached, the running screens are seen as shown below:

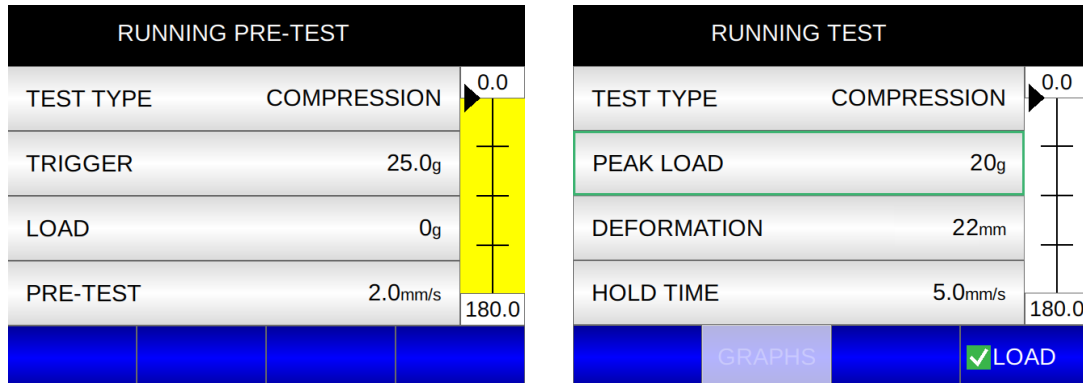

Figure III.9

Deformation and Load will remain live displays during the test.

Results are shown on the reporting screens:

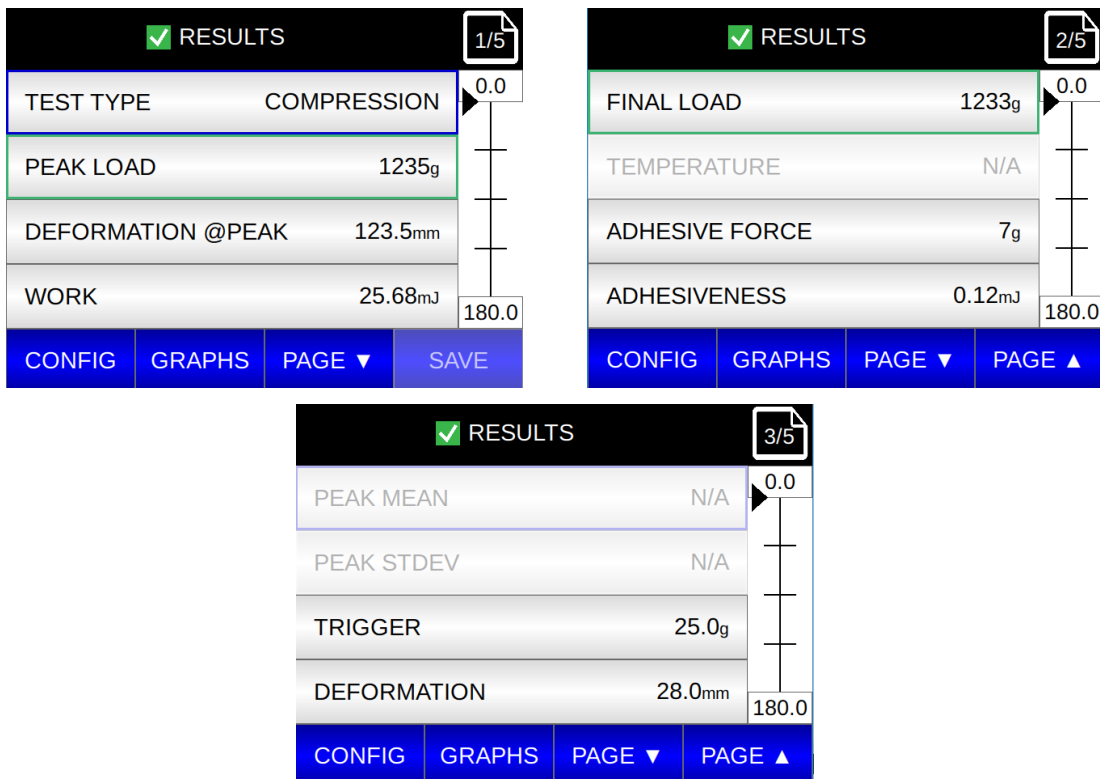

Figure III.10

TENSION TEST - this test can be used to pull apart a sample, usually using grip fixtures to apply tension load on the sample.

NOTE: It is not possible to perform tension tests with the 100g load cell.

The operator sets the trigger value, target deformation and the test speed using the Tension menu screen:

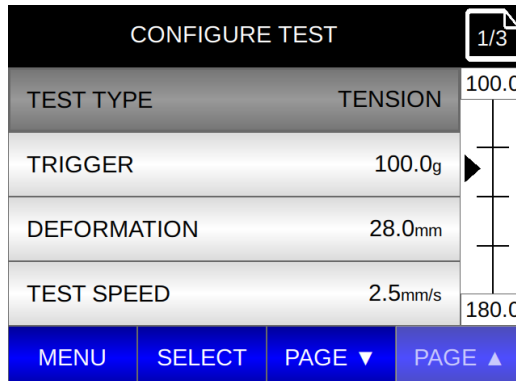

Figure III.11

Optional settings include hold time, cycle count, pre-test and post-test speeds as well as QC Load Low and High limits.

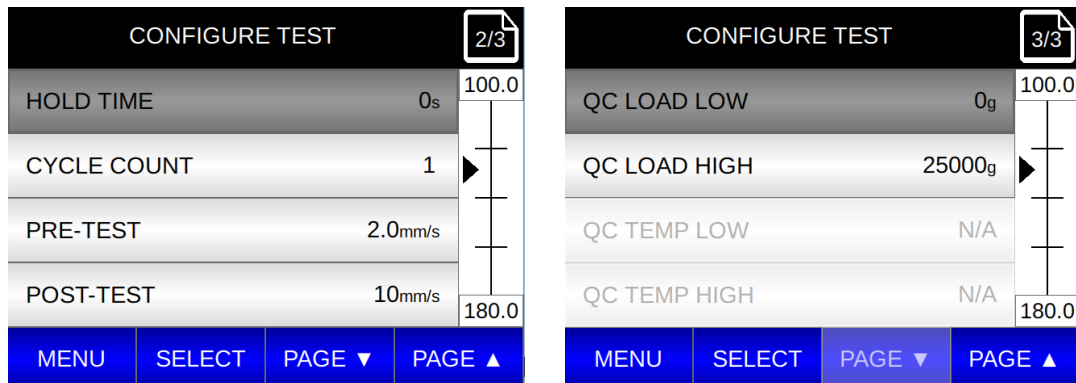

Figure III.12

After pressing START, the operator is presented with this reminder screen:

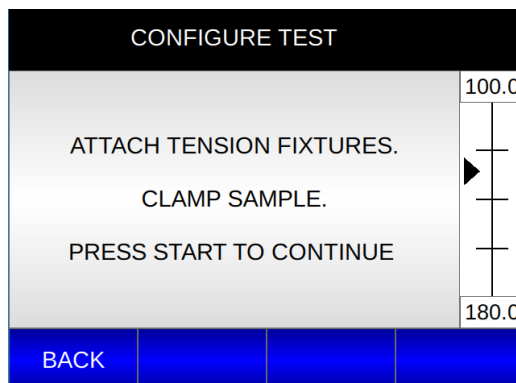

Figure III.13

Be sure grips or other sample fixtures are secure and aligned, then press START.

At any point, the Adjust Beam can be used to adjust the slack of the sample.

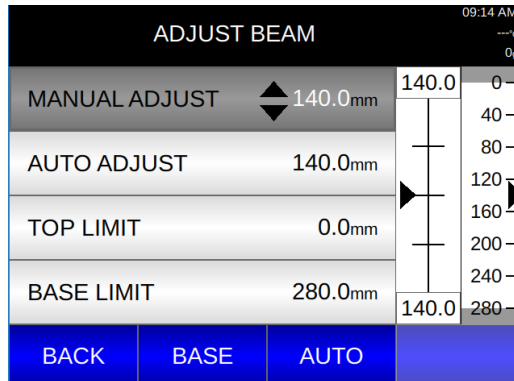

Figure III.14

The position value of 140.0 shown in this screen is the current distance of the beam from the top limit and as such shows how much travel is possible once the test begins. Be sure this value is greater than the sum of the distance necessary to reach the trigger plus the programmed target deformation.

NOTE: When clamping the sample, try to exert only minimal lateral loads on the probe shaft.

During the test the running screen is seen as shown below:

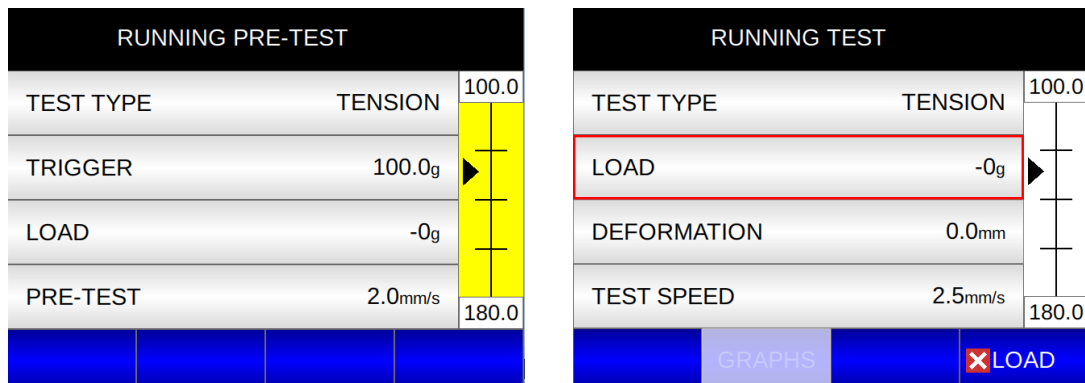

Figure III.15

Deformation and Load will display live data during the test. When deformation reaches the target value, the test stops.

Test results are shown on the reporting screen:

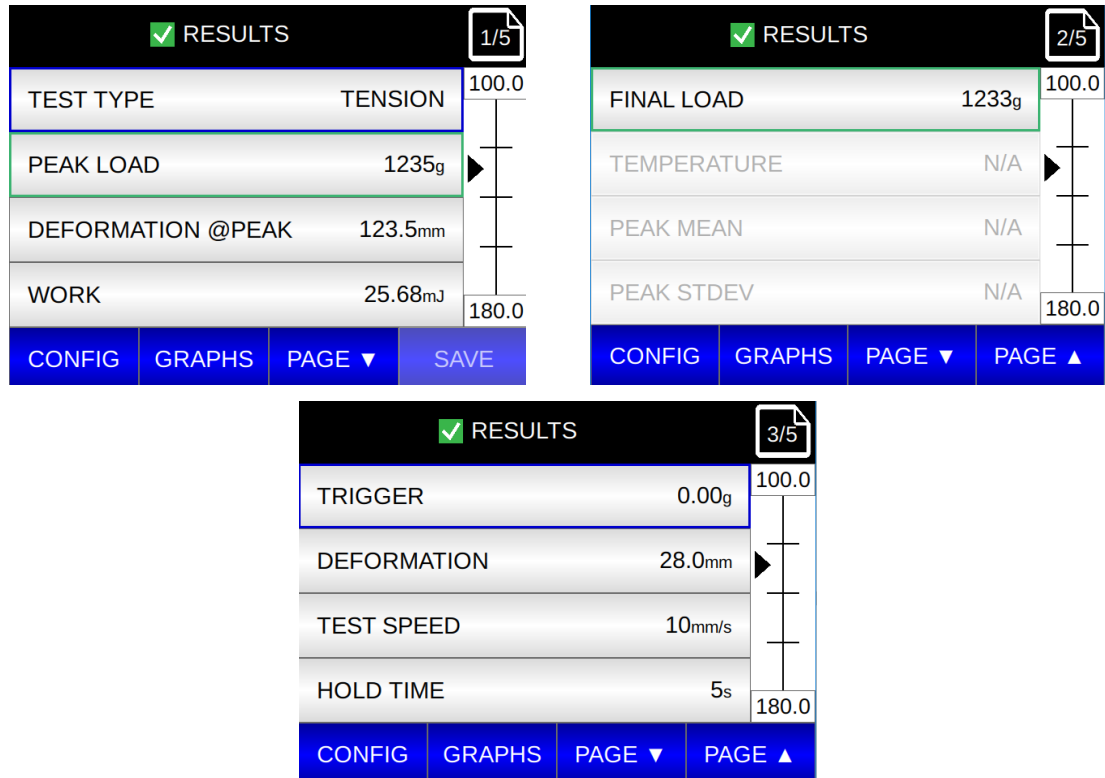
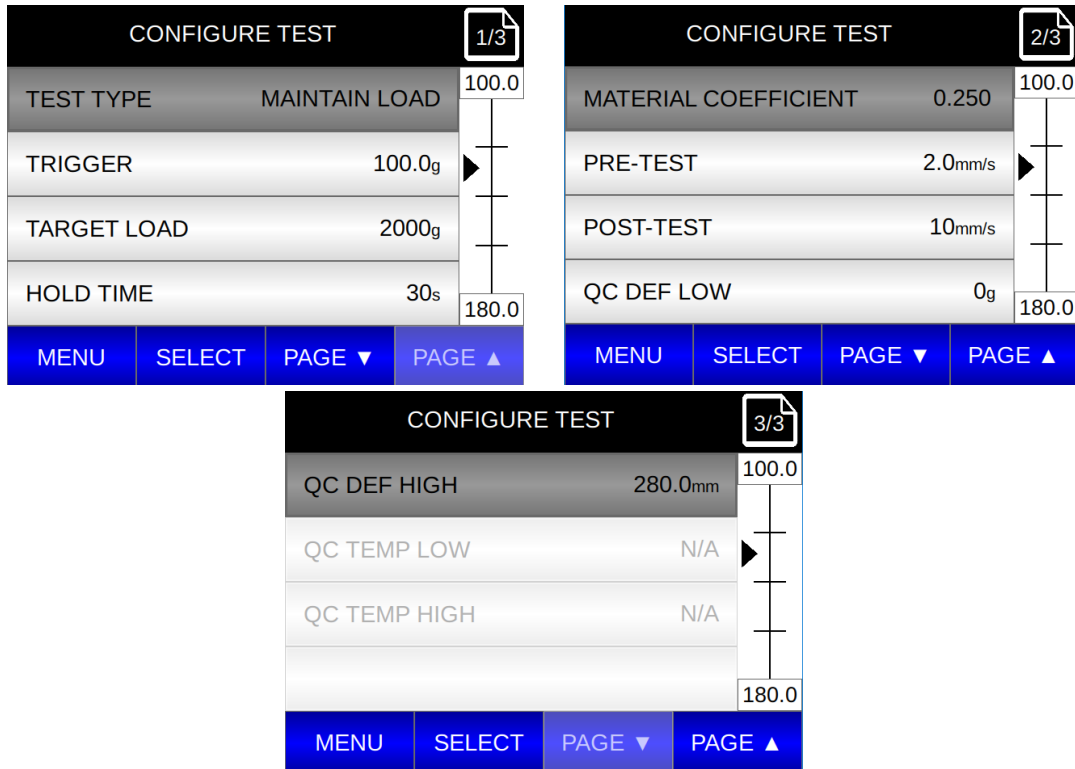

Figure III.16

MAINTAIN LOAD TEST – performs a single compression of the sample. The system maintains target load for a programmed amount of hold time before the probe returns to the starting position.

The operator sets the trigger value, target load, hold time and material coefficient using the Maintain Load menu screens:



**QC Limits are only shown if they, the admin, has made them user editable.*

Figure III.17

A maintain load test performs a single compression cycle when the operator depresses the start button. The test runs at a system determined test speed to the target load, then holds at this load for the programmed hold time. The countdown clock shows remaining hold time.

Material Coefficient is used to describe material characteristics for the CTX, to utilize in Maintain at Load test. In essence, Material Coefficient is inverse of the spring constant and it is measured in mm/kg. The selection of an appropriate material coefficient will ensure an optimal target approach. The User can experiment with adjusting the value of material coefficient in order to achieve smooth, fast approach to the target load, with no overshoot. As a starting point, the user can use the rule where hard material corresponds to a smaller material coefficient and soft material corresponds to a bigger material coefficient. The user can set a material coefficient from 0 - 20.

During the test the running screen is seen as shown below:

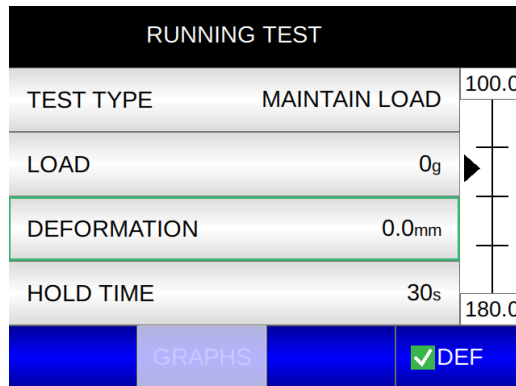

Figure III.18

Deformation and Load will remain live displays during the test. When the countdown clock reaches zero, the probe returns to home.

Test results are shown on the reporting screen:

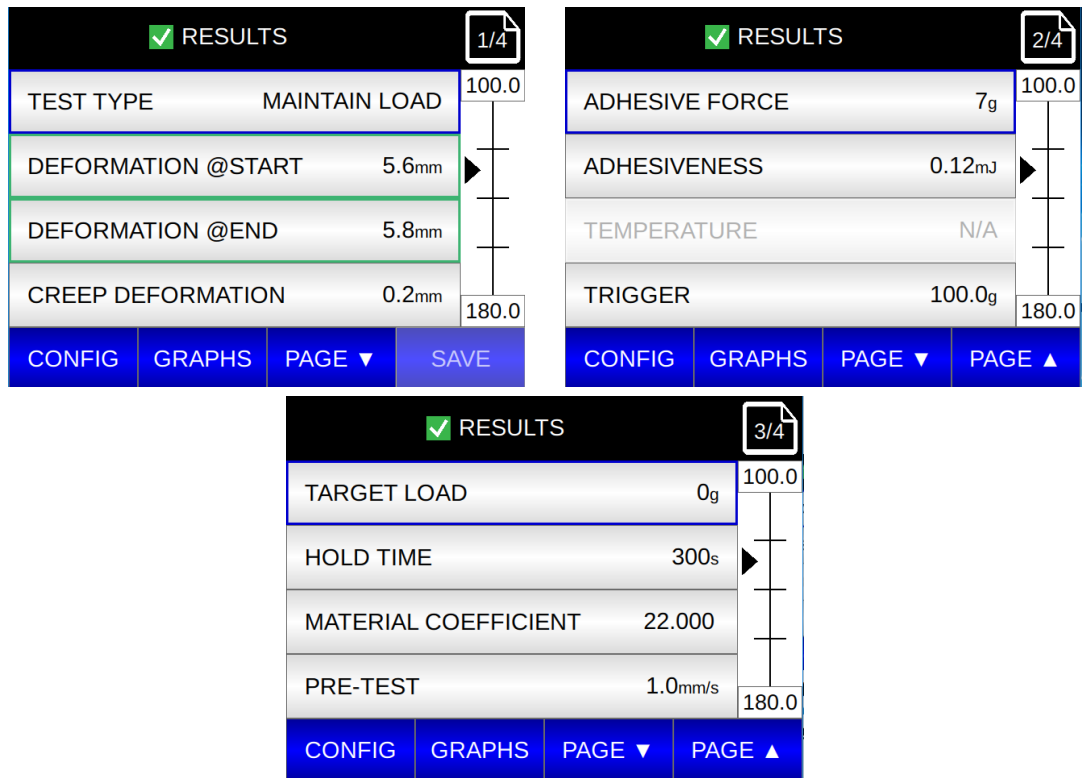

Figure III.19

STOP AT LOAD TEST – performs a single compression of the sample. The probe stops at the target load for programmed hold time before returning to the start position.

The operator sets the trigger value, target load, hold time and test speed using the Stop at Load menu screens:

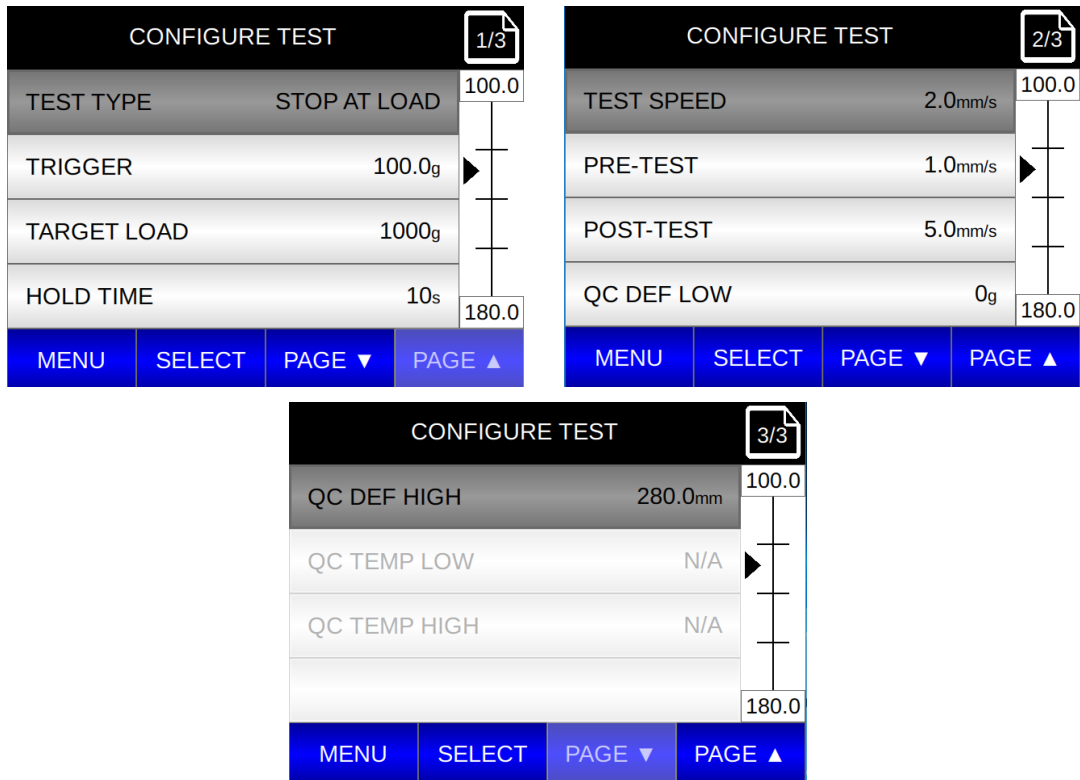

Figure III.20

While the test is running, the following screen is active.

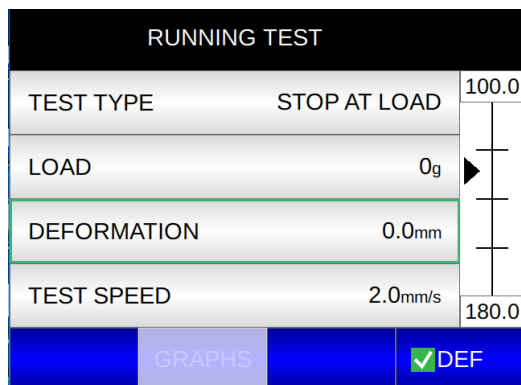

Figure III.21

A Stop at Load test performs a single compression cycle when the operator depresses the START button. The test runs at the users defined speed to the target load and stops at that load for the programmed hold time.

The following results screens appears at the conclusion of the test.

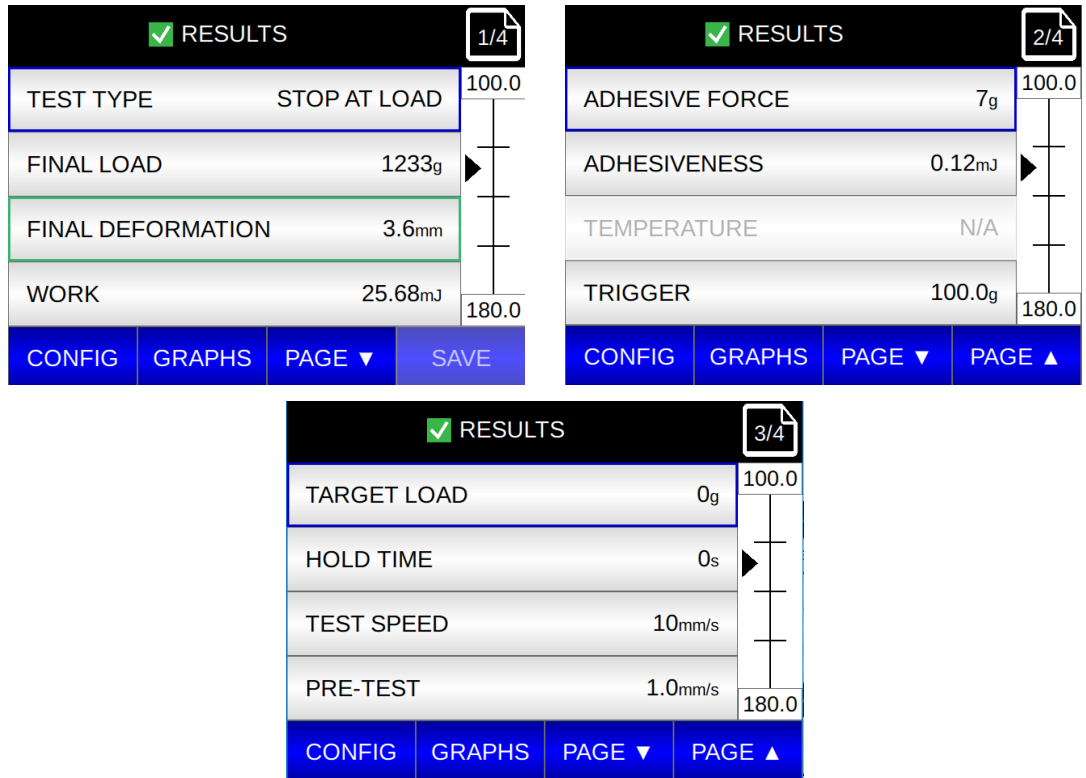

Figure III.22

RUPTURE TEST – performs a single compression of sample until the sample ruptures. The test result will be the distance the sample deformed before it ruptured and the peak load just prior to the rupture. As soon as the rupture occurs the probe retracts to the HOME starting position.

The operator may set the trigger value, correction value and test speed.

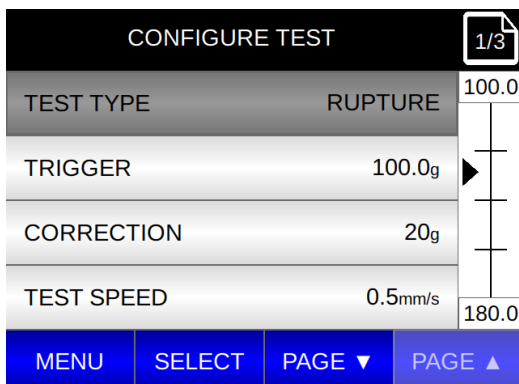

Figure III.23

Option settings: pre-test and post-test speeds, QC Load Low and High & QC Temp Low and High.

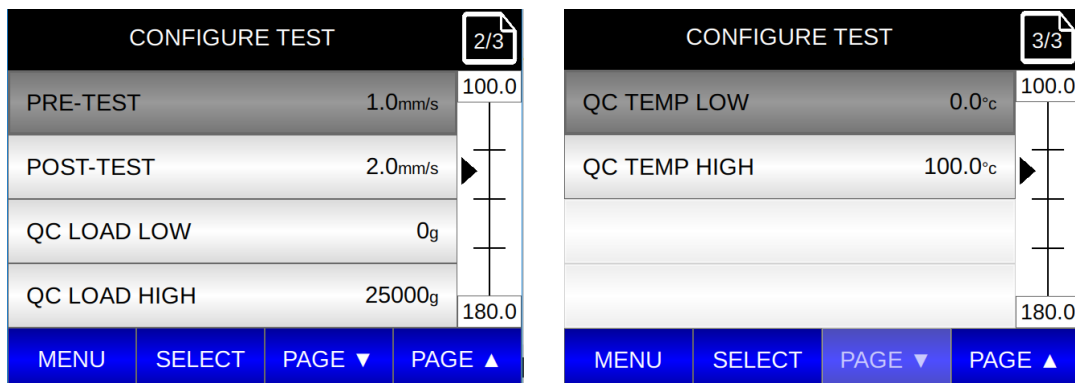

Figure III.24

The trigger value is a small load, in grams, measured by the CTX that indicates the probe is in contact with the sample. Once the probe contacts the sample, the test will begin at the defined speed. The range of acceptable trigger values depends upon the load cell in use and is shown in Table III.1. In general, the trigger value should be large enough to prevent a false trigger from starting the test before the probe comes in contact with the sample. A false trigger is usually the result of excessive vibrations passing through the lab bench.

When the sample ruptures, the load measured by the CTX will drop. The Correction value specifies the size of the load drop, in grams, that is required to recognize a rupture. The correction value is based on load cell. The low value is equal to the resolution of the load cell and the high value is equal to the max trigger setting of the load cell.

Press START to begin the test. The following screen is active while the test is running.

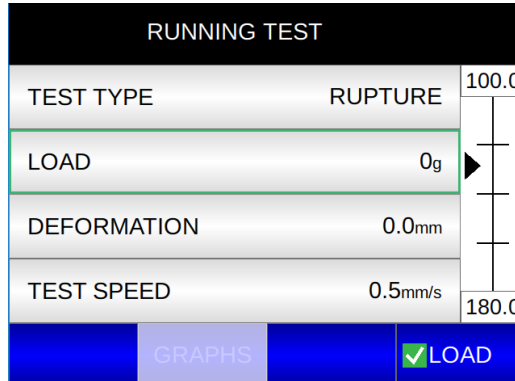

Figure III.25

As soon as the sample ruptures, the result screen will appear.

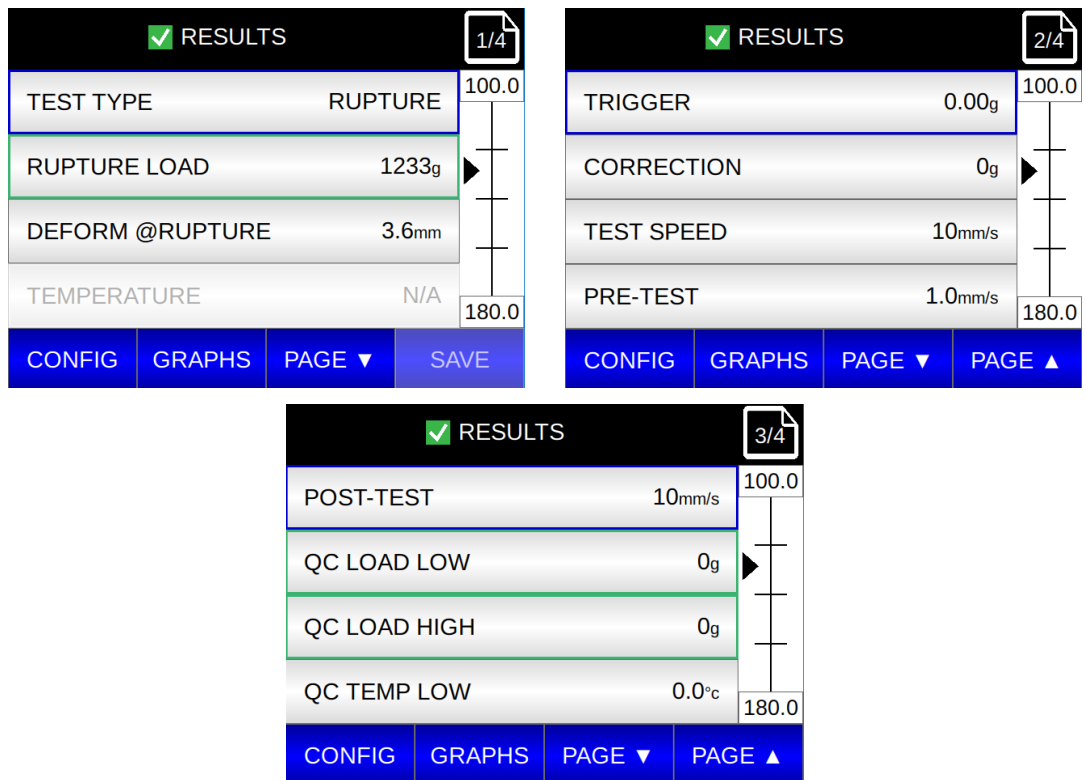

Figure III.26

If a temperature probe is used with the CTX, the temperature at the time of the test is also shown. The TEMP line will not be seen in the display if a temperature probe is not used. DO NOT insert the temperature probe into the sample being tested as it will affect the internal structure of the material.

BLOOM TEST – performs a single compression cycle using industry established test parameters and reports gelatin bloom strength. Use the TA10 probe.

Trigger, deformation and test speed are fixed in the Bloom Test specification.

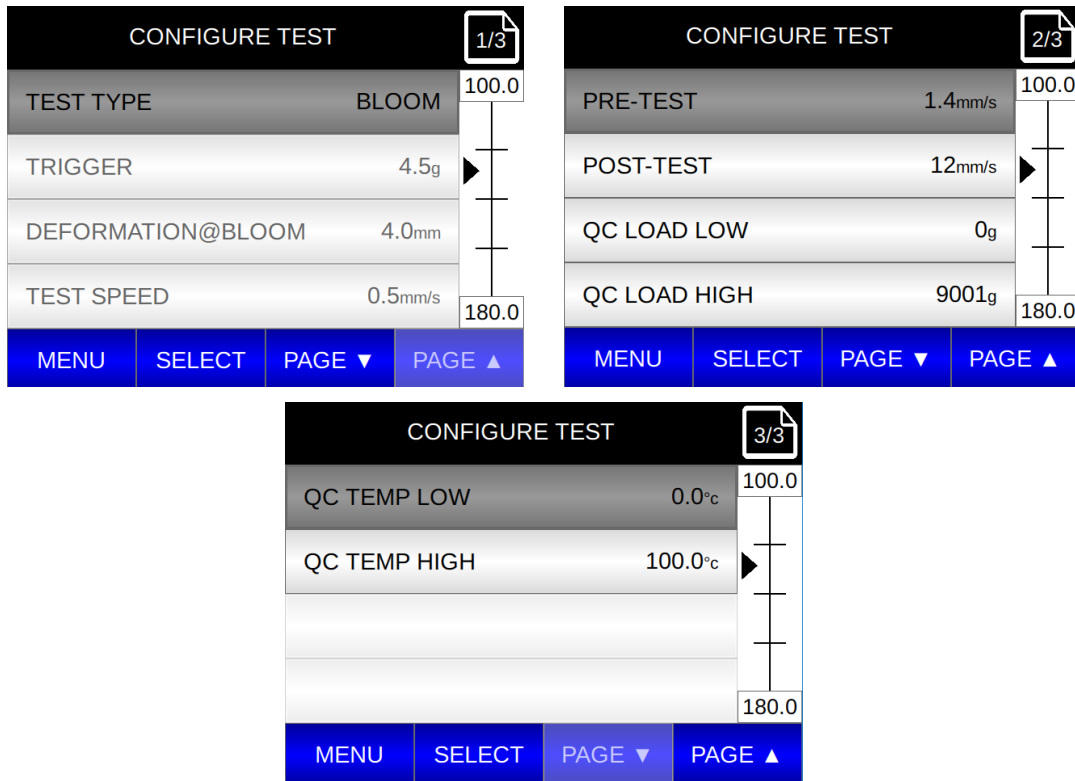

Figure III.27

When the operator depresses the start button the Bloom test performs a single compression cycle at 0.5mm/s to the target deformation of 4mm. During the test, the running screen is seen as shown below:

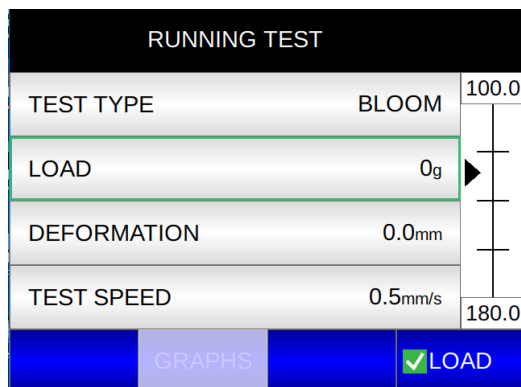

Figure III.28

Both Deformation and Load displays are live during the test. The probe then returns immediately to home/starting position.

Test results are shown on the reporting screens:

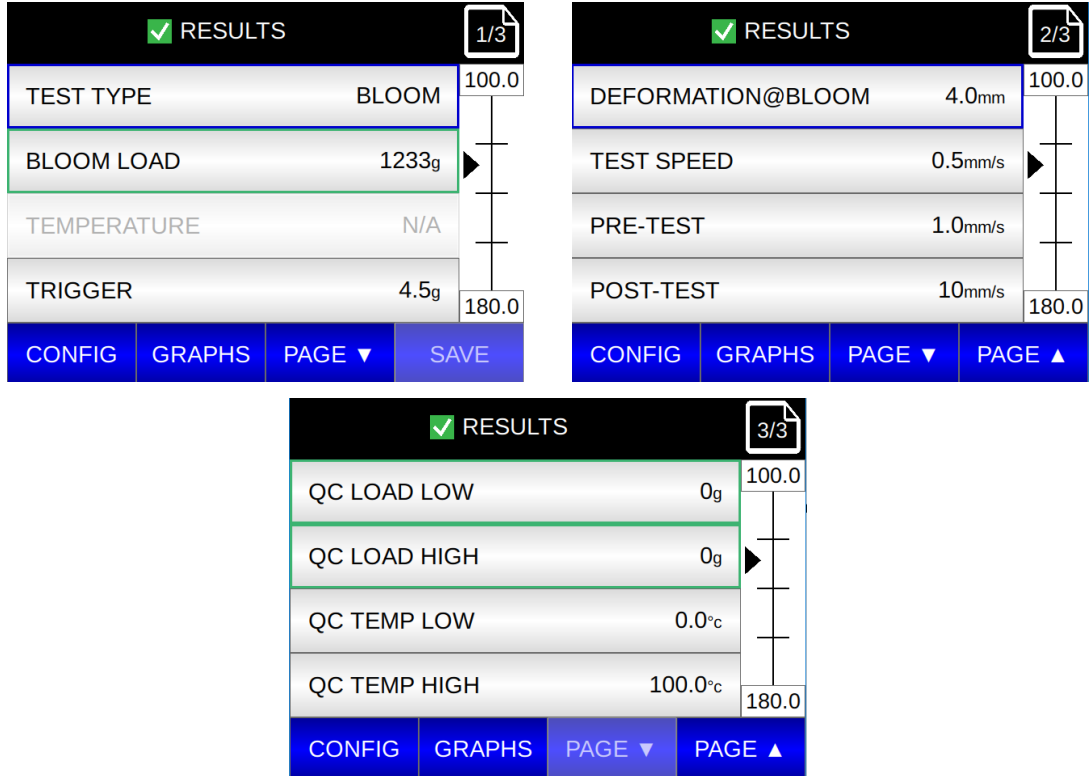

Figure III.29

Bloom load in grams is generally reported as “grams bloom”.

NOTE: It is not recommended to conduct bloom testing with load cells greater than 5000g. On instruments with load cells 10kg or higher, the bloom test will not appear on the menu.

SURIMI TEST – performs a single compression of a surimi sample until the gel ruptures. Use TA50 5mm diameter sphere probe. The test result will be the distance the sample deformed before it ruptured and the peak load just prior to the rupture. As soon as the rupture occurs, the probe retracts to the HOME start position.

The operator may set the trigger value, correction value and test speed.

CONFIGURE TEST		1/3
TEST TYPE	SURIMI	100.0
TRIGGER	5g	
CORRECTION	30g	
TEST SPEED	1.0cm/s	180.0
MENU	SELECT	PAGE ▼ PAGE ▲

Figure III.30

Option settings: pre-test and post-test speeds, QC Load Low and High & QC Temp Low and High.

CONFIGURE TEST		2/3
PRE-TEST	0.10cm/s	100.0
POST-TEST	1.0cm/s	
QC LOAD LOW	0g	
QC LOAD HIGH	500g	180.0
MENU	SELECT	PAGE ▼ PAGE ▲

CONFIGURE TEST		3/3
QC TEMP LOW	0.0°C	100.0
QC TEMP HIGH	100.0°C	
		180.0
MENU	SELECT	PAGE ▼ PAGE ▲

Figure III.31

The trigger value is a small load, in grams, measured by the CTX that indicates the probe is in contact with the sample. Once the probe contacts the sample, the test will begin at the defined speed. The range of acceptable trigger values depends upon the load cell in use and is shown in Table III.1. In general, the trigger value should be large enough to prevent a false trigger from starting the test before the probe comes in contact with the sample. A false trigger is usually the result of excessive vibrations passing through the lab bench. A 5g trigger is typical for surimi tests.

When the surimi sample ruptures, the load measured by the CTX will drop. The Correction value specifies the size of the load drop, in grams, that is required to recognize a gel rupture. The correction value may be set based on load cell. The two most common correction values used are 30g or 50g. See Table III.1.

The test speed for all surimi testing has historically been 1cm/s or 10mm/sec, so this is the default value.



Changing the test speed is likely to change the gel result.

During the test, the display will show live deformation and load.

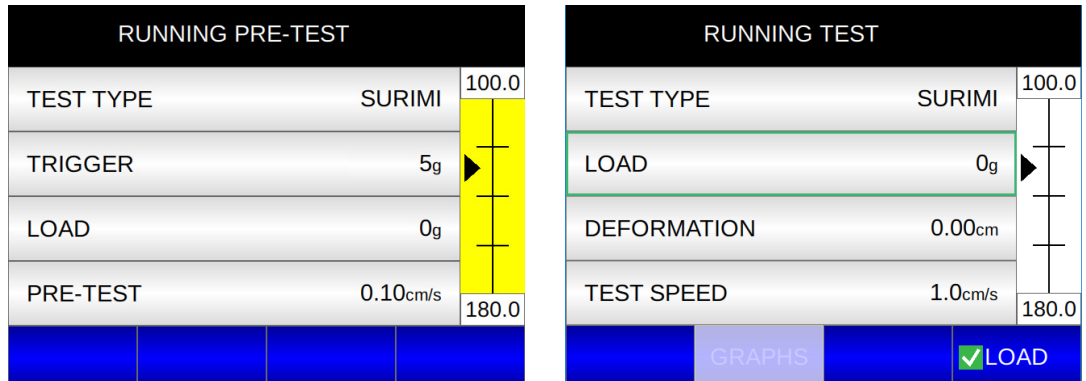

Figure III.32

As soon as the surimi gel ruptures, the result screen will appear:

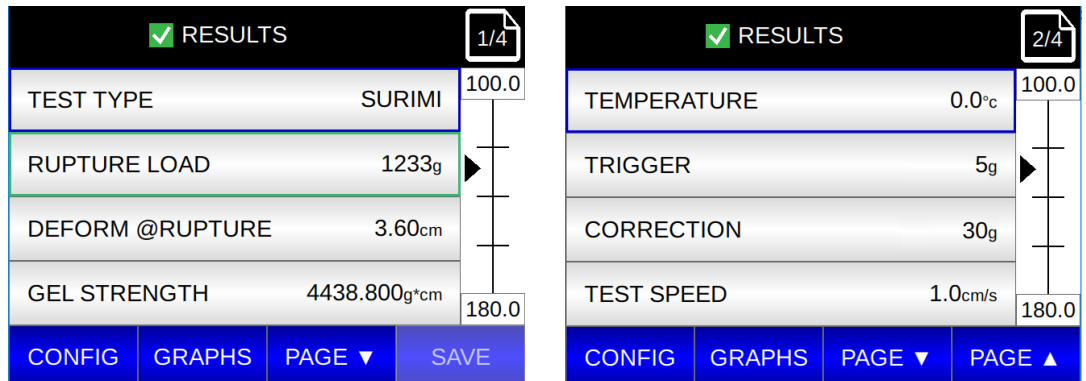

Figure III.33

The GEL strength result is the multiplication of Rupture Load and Deform@Rupture in units of g-cm.

If a temperature probe is used with the CTX, the temperature at the time of the test is also shown. The TEMP line will not be seen in the display if a temperature probe is not used. DO NOT insert the temperature probe into the surimi sample being tested.

TPA TEST – performs two compression cycles commonly on food item samples and reports established Texture Profile Analysis results.

The operator sets the trigger value, target deformation (travel distance into the sample) and the test speed using the TPA menu screen:

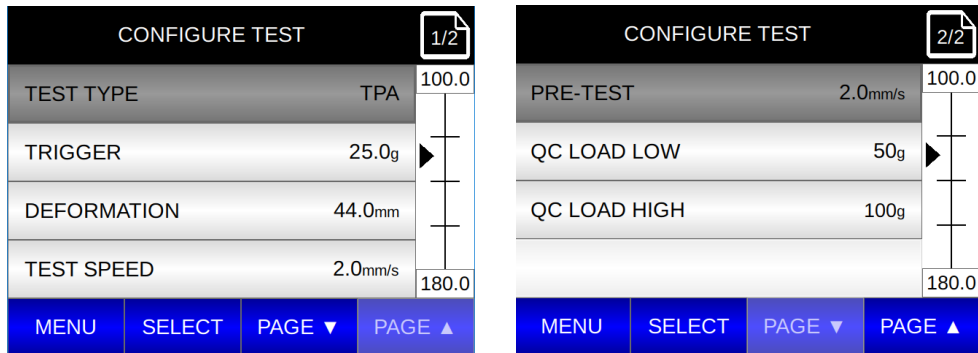

Figure III.34

The operator depresses the start button to begin the test. In a TPA test, the compression and return strokes of both cycles occur at the programmed test speed. Target deformation for both cycles begins at the trigger position of the first cycle.

During the test the running screen is seen as shown below:

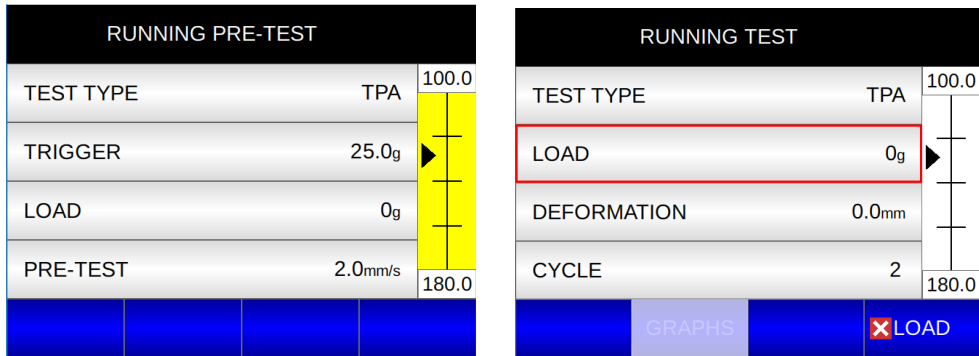

Figure III.35

After the first compression stroke, the probe returns to the home position and repeats the same compression stroke. TPA cycles will count down to show the number of cycles remaining. Deformation and Load will remain live displays during the test.

Test results are shown on the reporting screen:

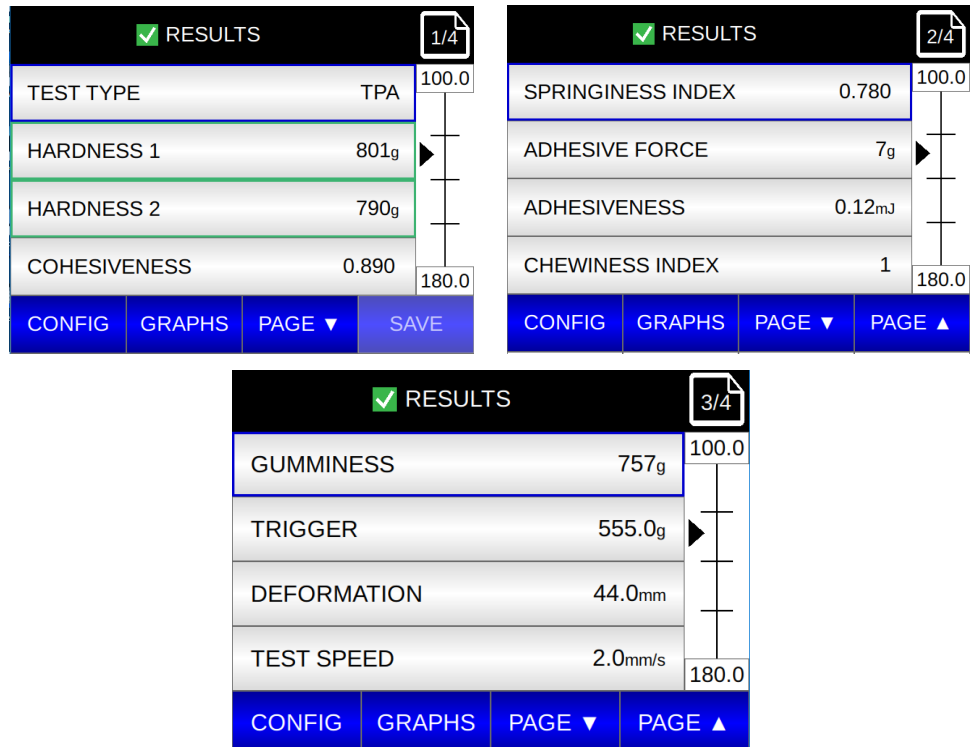

Figure III.36

Hardness 1 is the peak load of the first compression cycle.
 Hardness 2 is the peak load of the second compression cycle.

Cohesiveness is the ratio of A2/A1. A2 is the area under the compression stroke of the second cycle and A1 is the area under the compression stroke of the first cycle. If the structure of the sample is completely destroyed on the first compression, this ratio is zero. If the sample is perfectly elastic and not damaged at all by the first compression, this ratio is 1.0. Most food products will fall somewhere in between 0 and 1.

Springiness Index is a measure of how far the sample returns after being compressed to the target deformation.

Adhesion, or Adhesive force, is a measure of resistance to probe withdrawal from the sample on the first compression.

Adhesiveness, or stickiness, is calculated as the area under the negative curve on a force vs. distance graph as the probe withdraws from the first compression and returns to the start position.

Chewiness Index is the energy required to chew a solid food to the point needed for swallowing it.

Gumminess is the energy required to disintegrate a semi-solid food product to a state ready for swallowing.

TACK TEST – performs compression cycle on the sample, using Stop @ Load methodology and measures adhesive force as the probe withdraws from the sample.

The operator sets the trigger value, target load, and hold time using the Tack menu screen.

QC Tack Low & QC Tack High to be available soon.

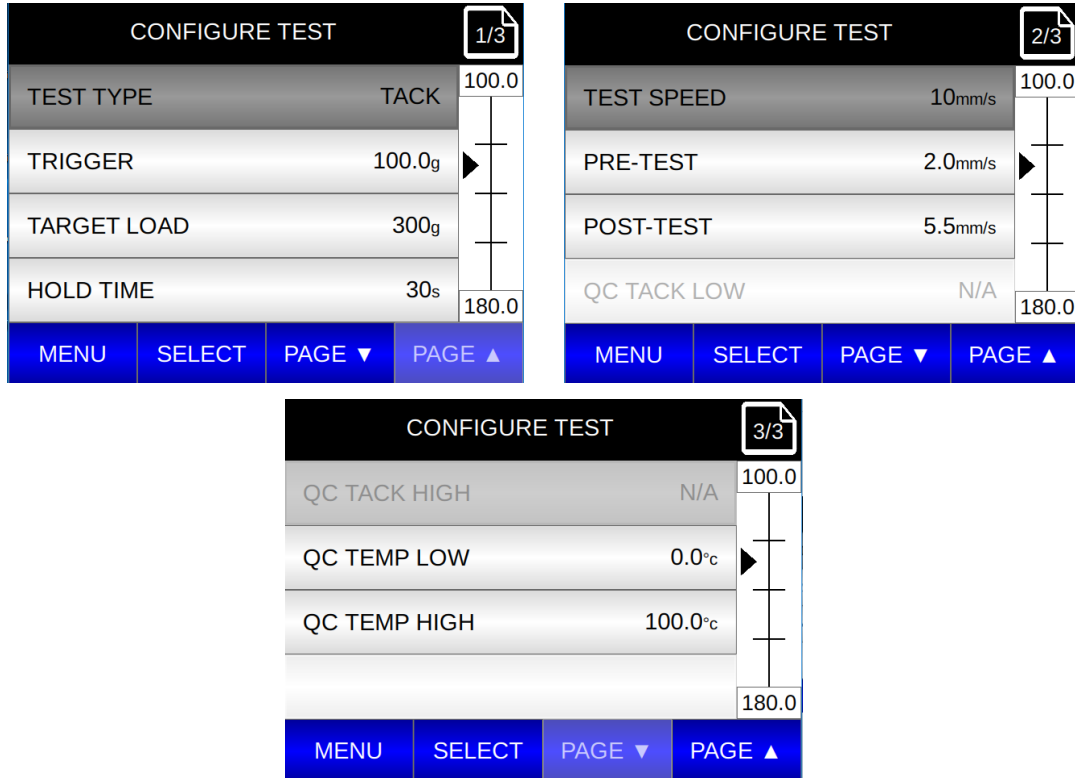

Figure III.37

While test is running live load and deformation values are displayed and the hold time counts down:

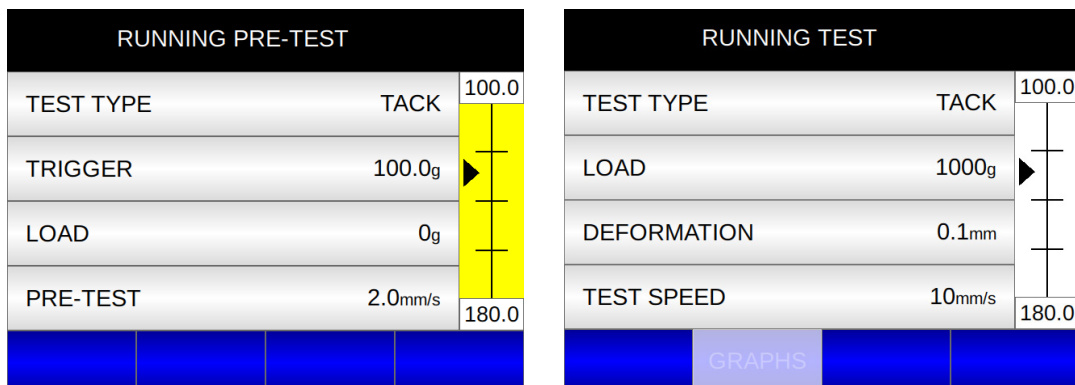

Figure III.38

A Tack test performs a single compression cycle when the operator depresses the START button. The system is measuring the adhesive force as the probe is retracting to the start position.

When the test is complete, the results are shown as below:

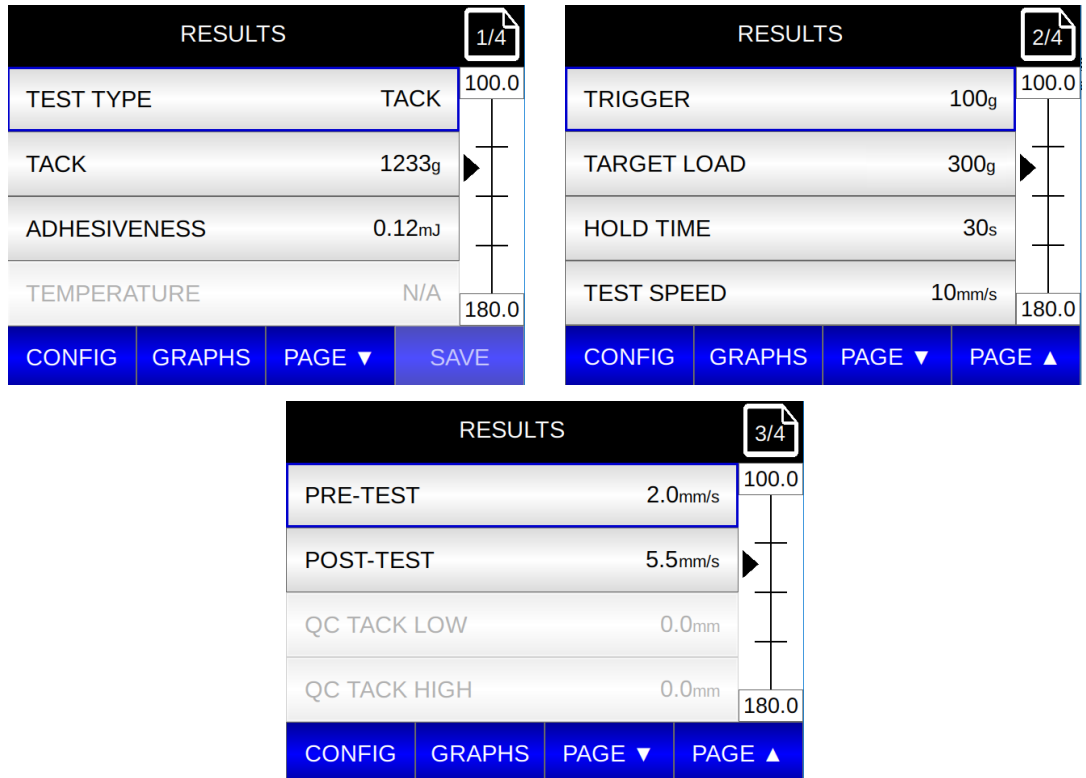

Figure III.39

STATIC LOAD TEST – measure load with certified weights to verify accuracy. We recommend that you use the Brookfield certified weight set appropriate for your CTX load ranges:

<u>Part No.</u>	<u>Load Range</u>
TA-CW-100C	100 gram
TA-CW-1000C	1000 gram
TA-CW-1500C	1500 gram
TA-CW-4500C	4500 gram (for use with 5kg)
TA-CW-10KGC	10kg
TA-CW-2550KGC	25kg, 50kg and 100kg

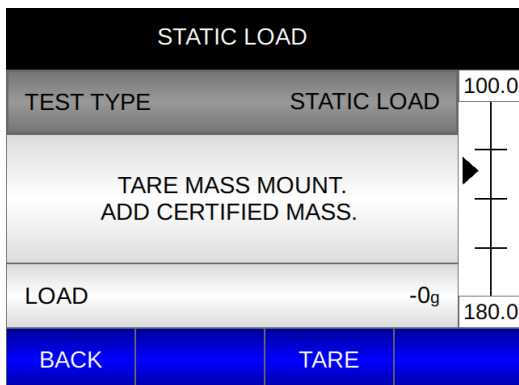

Figure III.40

NOTE: Load recorded will be the calibrated load.

The frequency of the calibration verification should be set in accordance to your company procedures.

<u>Load Cell</u>	<u>Load Range Grams</u>	<u>Load Cell Accuracy Grams</u>
CTX001	0 - 100	0.2
CTX010	0 - 1000	2.0
CTX015	0 - 1500	3.0
CTX050	0 - 5000	10
CTX100	1 - 10000	20
CTX250	2 - 25000	50
CTX500	5 - 50000	100
CTX01K	10 - 100000	200

TRAVEL CHECK TEST – performs a distance calibration check using a 1-inch gauge block.

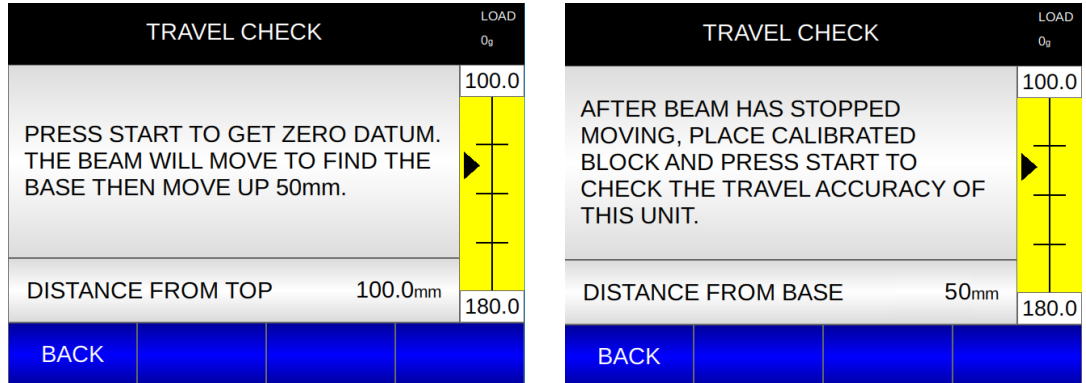

Figure III.41

Test starts and travel check verifies accuracy of 1-inch of travel , using a 1-inch gauge block.

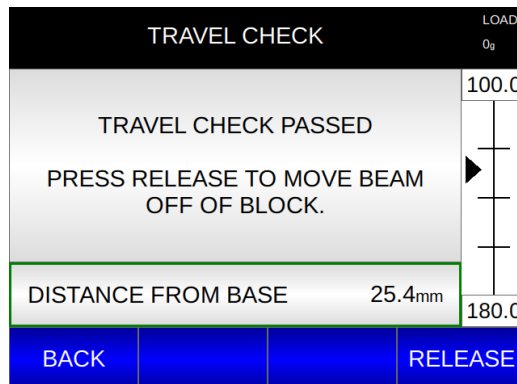

Figure III.42

III.9 Admin Functions

DEVICE SETTINGS – From the Main Menu, select DEVICE SETTINGS

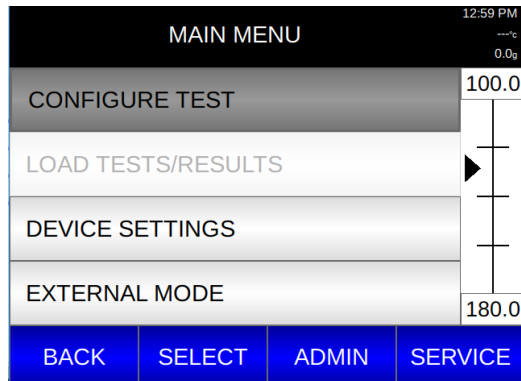

Figure III.43

First option is ABOUT: Where you can see the instrument and load cell information from the startup screen.

This is where you can also see the Load Units: in this case they are grams; and Temperature Units: in this case it is Celsius, and you can see the Temperature Offset.

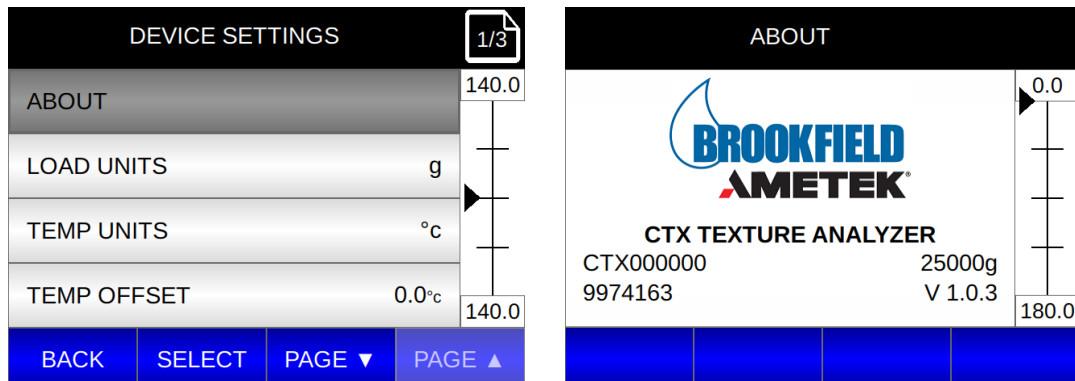

Figure III.44

The following screens show the date and the time formats as well as language and the filtering setting, in this case is set to Standard.

Filtering allows you to control the responsiveness of the Load signal. Filtering on allows you to adjust filtering in device settings. Filtering off uses default settings.

There are three filter options for the CTX and are listed as follows:

- DAMPENED - Low response filter, used for soft solid material, improves smoothness of load signal.
- STANDARD - Medium response filter, for use with 95% of texture applications.
- HIGH RESPONSE - User for capturing multiple fractures of potato chips or Stop at Load Test.

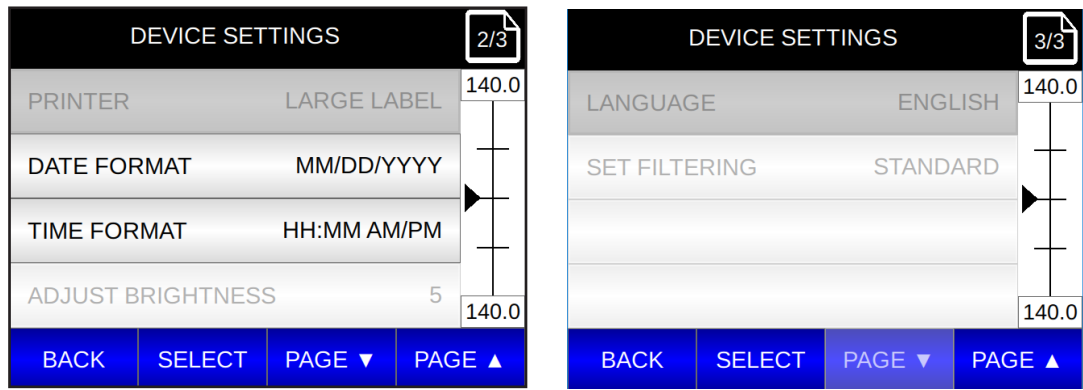

Figure III.45

ADMIN SETTINGS – To get to the Admin screens, press the ADMIN button on the main menu.

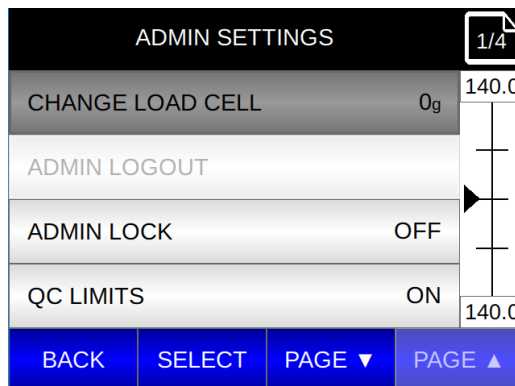

Figure III.47

- Select Change Load Cell to make a change to your load cell.
- Admin Logout will log you out if you are logged in as the Admin.
- Admin Lock requires a password if On is selected.
- QC Limits On allows you to set the QC limits as part of the test configuration.

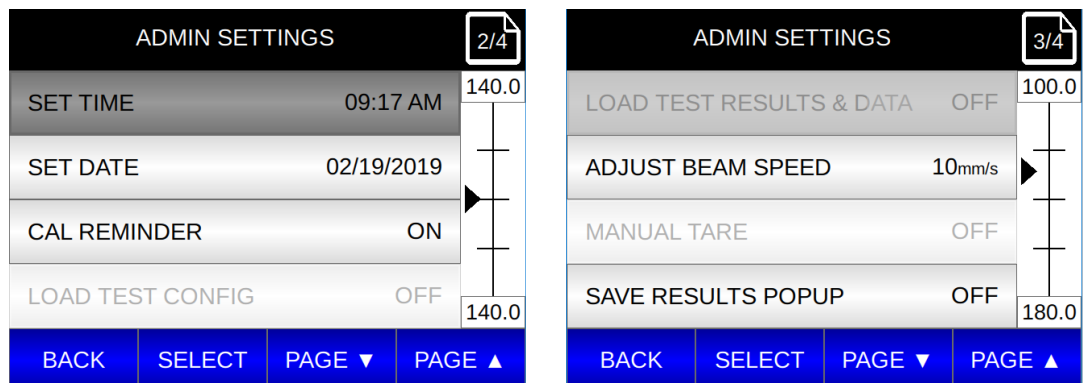

Figure III.48

- Set Time allows you to set the clock.
- Set Date allows you to set the date.
- Cal Reminder On - a popup window will appear for calibration due.
- Load Test Results and Data allows you to load tests from a USB.
- Adjust Beam Speed allows you to alter the speed setting.
- Manual Tare, when set to Yes, it can be set as part of the configuration in tension tests.
- Save Results Popup - default is off, if On, a popup appears after every test.

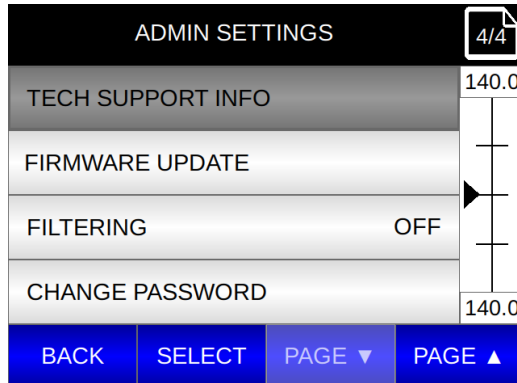

Figure III.49

- Tech Support Info - if selected, displays Firmware version, Serial Number and Load Range.
- Firmware Update - Firmware can be updated via USB upload.

CHANGE LOAD CELL – select Change Load Cell from the ADMIN screen

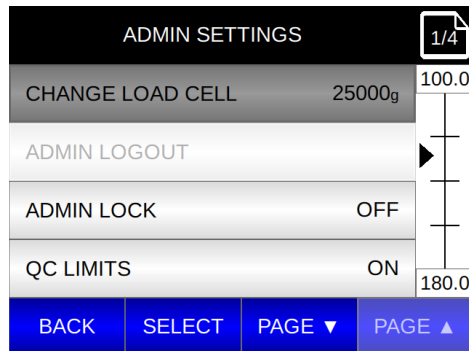

Figure III.50

Follow the instructions on the screens.

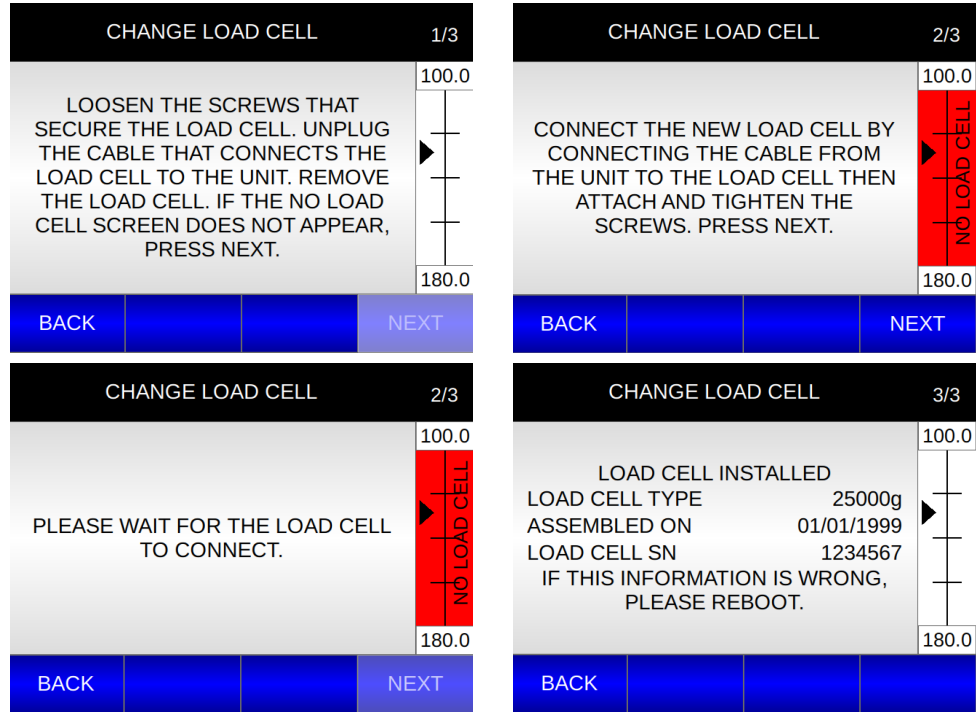

Figure III.51

NOTE: It is recommended that you turn your instrument off when changing load cells. The user can also change the load cell through the ADMIN screen.

EXTERNAL MODE – to be used when operating our CTX with the Texture Pro Software.

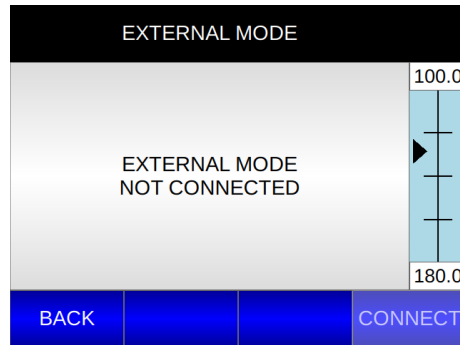

Figure III.52

IV. TEST METHOD DEVELOPMENT

The measurement results provided by the CTX Texture Analyzer will be dependent on several factors relating to the sample, the test probe, and the test parameters. A variation on any of these elements may result in a change in measurement results. For good test repeatability, it is suggested that a clear and complete test method be developed. The following sections describe these elements. Brookfield suggests that your method development include some trial and error testing to determine the best test method for your sample material. Brookfield offers a texture day training course for anyone wishing assistance with texture analysis methods.

IV.1 Sample Preparation

The measurement of texture using the CTX Texture Analyzer requires contact between the test probe and the sample. The shape and surface of the sample may affect the measurement results. Consider for example an orange: the test of a peeled orange will likely give a different result from the test of a single wedge from the same fruit. This is likely the same for any bulk material when compared to a neatly prepared cube of material. Consideration should be given to the preparation of the sample to facilitate repeatability of the test. For example, a material that has a flat surface offers a consistent interface with the probe even if the material is not centered in the test fixture. If your test sample is uneven, part of the test method could be to cut, shape or modify the sample such that the sample is flat; consider, for example, the difference between a loaf of bread versus a slice of bread.

IV.2 Test Probe / Fixture

The CTX Texture Analyzer may be used with a wide variety of probes and fixtures. AMETEK Brookfield offers a set of standard items while also providing special design services. Each type of probe offers benefits for certain sample types. The following table provides some basic guidelines. Although this table represents our general experience, it is important to note that there are few established standard tests for physical measurements of texture. The main objective is to characterize your material in a way that best represents its perception by human senses. This is the essence of texture analysis.

<u>Probe Type</u>	<u>Typical Application</u>
Cylinder	Well defined samples with uniform surfaces, general purpose, TPA (texture profile analysis)
Sphere	Samples with small scale variations on the surface, general purpose
Cone	Samples with rigid outer layer, also used for Penetrometry and spreadability
Wire	Used for cutting or slicing samples such as cheese
Magness Taylor	Used for puncturing, often used for determining ripeness of fruit/vegetables
Extrusion Cell Shear blades	Samples that can be made to flow, general purpose meat tenderness

Table IV.1

Within a probe category, variations of geometry can be significant. It may require a larger force to drive a cone of shallow angle as compared to a cone of steep angle. Similarly, a cylinder of large diameter may require a larger force than a cylinder of small diameter. The selection of the probe (type and size) will affect the test result.



Keep hands, fingers and other body parts clear of moving test probes when operating instrument.

IV.3 Test Parameters

The CTX Texture Analyzer will require the setting of several parameters depending upon the test method selected (see Table III.1). In general, the following relationships will hold true for Speed and Distance.

- 1) The measured load tends to increase as the test speed increases.
- 2) The measured load tends to increase as the compression distance increases. An exception to this could be a material with an outer layer such as an apple, or one that fractures.

The Trigger Point establishes the minimum load required to begin the test. This is how the CTX knows when the probe is touching the sample. This parameter should be set to a low value for a material with a very delicate outer layer. Trigger value depends upon your load cell. Minimum recommendations are shown in Table III.1.

The Hold Time allows for monitoring the response of a material as it is held compressed. Normally, an increase in the Hold Time will result in a lower measured value, as the sample relaxes.

The Hold to Load stops a probe at the target load.

The Cycle Count provides a way of working a sample by compressing it repeatedly and monitoring its response.

IV.4 Recommendations

The test results of a texture measurement are very dependent on both sample preparation and the test method. When developing a method, Brookfield recommends that each parameter be varied in turn to determine its effect on the results. (*Note:* vary only one parameter at a time.) Once this information is considered and a method is established, the method should be documented in significant detail. This will ensure good repeatability of results and good comparison with others who attempt to duplicate your method.

For additional application information, visit our website at www.brookfieldengineering.com.

Appendix A - Probes, Fixtures, Calibration Accessories and Gelatin Accessories

This section provides part numbers and detailed descriptions for the test probes and fixtures that can be used with your Brookfield Texture Analyzer. Also included is information on calibration accessories and the equipment used to perform gelatin Bloom tests.

A-1 Probes

SELECTED PROBE KITS

TA-P-KIT2

RECOMMENDED GENERAL PROBE KIT

Includes the following probes: 60 degree cone TA2/1000; 12.7mm cylindrical (BS std) TA5; 60mm wide knife edge TA7; 1.0mm dia. needle TA9; 12.7mm cylindrical (AACC std) TA10; 25.4mm cylindrical (AOAC std) TA11/1000; 45 degree cone TA15/1000; 30 degree cone TA17; 12.7mm ball TA18; 50.8mm cylinder TA25/1000; 0.33mm cutting wire TA53; 2mm rod TA39; 38.1mm cylinder TA4/1000; 6mm cylindrical TA41; 25.4mm ball TA43; 4mm cylinder TA44 and TA-PCC

TA-P-KIT3

CURD PROBE KIT

Includes the following probes: 5mm disc TA46; 8mm disc TA-47; 10mm disc TA48 and storage case.

CYLINDER / ROD PROBES

* *included in TA-P-KIT2*

TA3/100

25.4mm DIAMETER CYLINDER PROBE

Clear Acrylic. 35mm Long. Rad 0.35 - 0.43mm.

TA3/1000

25.4mm DIAMETER CYLINDER PROBE

Clear Acrylic. 35mm Long. Rad 0.35 - 0.43mm.

TA4/100

38.1mm DIAMETER CYLINDER PROBE

Clear Acrylic. 20mm Long. Rad 0.35 - 0.43mm.

TA4/1000

* **38.1mm DIAMETER CYLINDER PROBE**

Clear Acrylic 26g. 20mm Long. Rad 0.35 - 0.43mm.

TA5

* **12.7mm DIAMETER CYLINDER PROBE**

Black Delrin 5g. 35mm Long. Rad 0.35 - 0.43mm.

TA6

6.35mm DIAMETER CYLINDER PROBE

Black Delrin. 20mm Long. Rad 0.35 - 0.43mm.

TA10

* **12.7mm CYLINDER PROBE**

Clear Acrylic 5g. 35mm length with sharp edge. Gelatin Bloom Probe

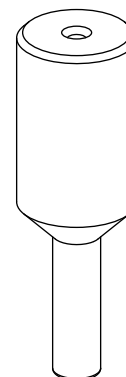

TA11/100	25.4mm AOAC STANDARD CYLINDER PROBE Clear Acrylic. 35mm Long.
TA11/1000	* 25.4mm AOAC STANDARD CYLINDER PROBE Clear Acrylic 21g. 35mm Long.
TA19	1cm² KOBE TEST PROBE Stainless Steel. 11.3mm Diameter. 25mm Long.
TA24	4mm DIAMETER ROD PROBE Black Delrin. 20mm Long, Flat End
TA25/1000	* 50.8mm DIAMETER CYLINDER PROBE Clear Acrylic 23g. 20mm Long. Rad 0.35 - 0.43mm.
TA35	5mm DIAMETER CYLINDER PROBE Black Delrin. 20mm Long.
TA36	7mm DIAMETER CYLINDER PROBE Stainless Steel. 35mm Long.
TA39	* 2mm DIAMETER ROD PROBE Stainless Steel 5g. 20mm Long. Flat End (Margarine).
TA40	4.5mm DIAMETER ROD PROBE Stainless Steel. 20.5mm Long. Flat End (Margarine).
TA41	* 6mm DIAMETER CYLINDER PROBE Stainless Steel 7g. 35mm Long.
TA42	3mm DIAMETER CYLINDER PROBE Stainless Steel. 35.8mm Long.
TA44	* 4mm DIAMETER CYLINDER PROBE Stainless Steel 10g.
TA45	1mm DIAMETER CYLINDER PROBE Stainless Steel.
TA54	38.1mm DIAMETER 170° SHALLOW ANGLE CYLINDER PROBE Clear Acrylic. 20mm Long.

CONICAL PROBES

** included in TA-P-KIT2*

TA2/100	60° CONE PROBE Clear Acrylic. 30mm Diameter.
TA2/1000	* 60° CONE PROBE Clear Acrylic 15g. 30mm Diameter, 36mm L
TA15/100	45° CONE PROBE Clear Acrylic. 30mm Diameter.
TA15/1000	* 45° CONE PROBE Clear Acrylic 13g. 30mm Diameter, 40mm L
TA16	40° CONE PROBE Clear Acrylic. 29mm Diameter 41mm L
TA17	* 30° CONE PROBE Clear Acrylic 8g. 24mm Diameter, 46mm L
TA27	20° CONE PROBE Clear Acrylic. 12.4mm Diameter.
TA29	15° CONE PROBE Stainless Steel. 8mm Diameter.
TA32/100	90° CONE PROBE Clear Acrylic. 30mm Diameter.
TA32/1000	90° CONE PROBE Clear Acrylic. 30mm Diameter.
TA-PCC	PROBE CARRYING CASE For Texture Analyzer Probes And/Or Calibration Weights. (Foam Insert Cut To Order). Black Polypropylene - 225mm(L)X 200mm(W) X 70mm(H).

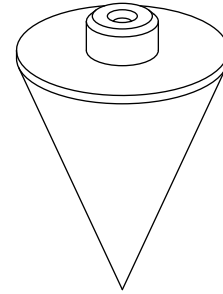

SPHERICAL PROBES

** included in TA-P-KIT2*

TA8	6.35mm DIAMETER BALL PROBE Stainless Steel.
TA18	* 12.7mm BALL PROBE Stainless Steel 30g
TA28	2mm DIAMETER BALL PROBE Stainless Steel.

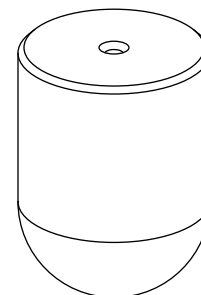

TA31	1mm DIAMETER BALL PROBE Stainless Steel.
TA33	3mm DIAMETER BALL PROBE Stainless Steel.
TA38	10mm DIAMETER BALL PROBE Stainless Steel.
TA43	* 25.4mm DIAMETER BALL PROBE Nylon 14g
TA49	25.4mm DIAMETER ROUND END Clear Acrylic.
TA50	5mm DIAMETER BALL PROBE Surimi application

MISCELLANEOUS PROBES

** included in TA-P-KIT2*

*** included in TA-P-KIT3*

TA-DGF001	DUAL GRIP FIXTURE These are multipurpose general grips for tensile type testing. The 25mm wide grips are fitted with rubber inserts to maximize contact adhesion with sample and are capable of holding rectangular samples up to 5mm thick. Each grip clamps from both sides of sample with two opposing thumbscrews for precise alignment. Includes one pair of T-Bolts for mounting to base. Base table kits are NOT USED with this fixture.
TA7	* KNIFE EDGE Clear Acrylic 8g. 60mm Wide.
TA9	* NEEDLE PROBE Stainless Steel. 1.0mm Diameter. 43mm Long. 10° Maximum Taper.
TA22	18SWG BAR FRAME PROBE Aluminum Frame. 39mm Wide. 1.2mm Diameter
TA23	12.7mm DIAMETER ROUND END PROBE Black Delrin. 35mm Long.
TA46	** TA CURD PROBE 5mm Stainless Steel, 5mm dia. disc (0.2 sq. cm)
TA47	** TA CURD PROBE 8mm Stainless Steel, 8mm dia. disc (0.5 sq. cm)

- TA48** **** TA CURD PROBE 10mm**
Stainless Steel, 10mm dia. disc (0.8 sq. cm)
- TA37** **2.36mm DIAMETER CUTTING WIRE PROBE**
Aluminum Frame. 40mm Wide.
- TA52** **Small Scale MOHRS Shear Blade**
Includes one blade holder and five blades. Blades are 9mm Wide x 35mm Length x 0.5mm Thick
- TA53** * 33mm D Cutting Wire Probe, 40mm L, Connects to M6 Female Thread

A-2 Fixtures

ACCESSORIES FOR ROTARY BASE TABLE

- TA-RT-KIT** **ROTARY BASE TABLE**
Round base table provides quick and easy height adjustment to accommodate various samples. Accessories listed below are mounted onto this table to facilitate special sample holding requirements. Includes pair of T-bolts for securing table.

ALL ACCESSORY FIXTURES BELOW MOUNT ONTO ROTARY BASE TABLE

- TA-ATT** **ADHESIVE TACK TESTER**
This tester is used for measuring stickiness of pressure sensitive adhesive materials such as tape. Requires Rotary Base Table TA-RT-KIT.
- TA-AVJ** **ADJUSTABLE VICE JIG**
This fixture is used for holding small samples for a puncture test. Good for Jelly beans, gum drops, etc. Requires Rotary Base Table TA-RT-KIT.
- TA-BEC** **BACK EXTRUSION CELL**
The Back Extrusion Cell is used for measuring the consistency of applesauce, pudding, yogurt and similar products. It consists of 3 containers with internal dimensions of 38.1mm diameter, 24mm deep; includes one 25.4mm diameter probe. Requires Rotary Base Table TA-RT-KIT.
- TA-JTPB** **JUNIOR THREE POINT BEND FIXTURE**
Small scale three point bend fixture for fracture test of brittle materials. Probe used with this fixture, TA7 Knife Edge Blade, is included in General Probe Kit TA-P-KIT2. Otherwise, please order TA7 separately. Requires Rotary Base Table TA-RT-KIT.

- TA-JPA** **JUNIOR PUNCH ASSEMBLY**
 This accessory is used for punching through flat samples. Probe used with this assembly, TA10, is included in General Probe Kit TA-P-KIT2. Otherwise, order TA10 separately. Requires Rotary Base Table TA-RT-KIT.
- TA-TBLT** Pair of T-bolts with nuts and washers.

ACCESSORIES FOR FIXTURE BASE TABLE

- TA-BT-KIT** **FIXTURE BASE TABLE**
 Rectangular base table with removable insert, which is used as a test surface. All accessories listed below mount into this table when the insert is removed. Pair of T-Bolts for securing the table are included. Four sets of extension legs (1, 1.5, 2 & 4 Inches) are supplied. Extra extension legs may be purchased separately.
- TA-BT-3KY** **Set of four 1 inch table leg extensions**
- TA-BT-2KY** **Set of four 1.5 inch table leg extensions**
- TA-BT-7KY** **Set of four 2 inch table leg extensions**
- TA-BT-8KY** **Set of four 4 inch table leg extensions**
- TA-BT-6KY** **Set of two thumbscrews for base table insert**

ALL ACCESSORY FIXTURES BELOW MOUNT ONTO FIXTURE BASE TABLE

- TA-AACC21** **AACC RECOMMENDED 21mm DIAMETER PROBE**
 Aluminum Cylinder, 21mm D and 40mm L. Requires Fixture Table Base TA-BT-KIT.
- TA-AACC36** **AACC SPEC PROBE (36mm)**
 This probe is used for measuring bread firmness and performing texture profile analysis (TPA). Requires Fixture Table Base TA-BT-KIT.
- TA-BLS** **BILAYER SHEAR TEST FIXTURE**
 This fixture uses a guillotine blade to separate a bilayer tablet while measuring shear strength. Requires Fixture Base Table TA-BT-KIT.
- TA-BPS** **BLISTER PACK SUPPORT TEST FIXTURE**
 This fixture is used to measure the force required to remove the tablet from its blister pack. Requires Fixture Base Table TA-BT-KIT.
- TA-CEF** **CHEESE EXTENSIBILITY FIXTURE**
 This fixture measures the extensibility of a sample, such as molten cheese, to break point.
- TA-CJ** **CONFECTIONERY JIG**
 This fixture is used for holding candies and similar products for penetration testing. Requires Fixture Base Table TA-BT-KIT. Consists of bases and top plates with holes 4mm, 8mm and 12mm in diameter to allow through penetration of samples with probes slightly smaller than holes. One blank plate (no hole) is also included to serve as a test surface when needed.

TA-CKA	<p>CRAFT KNIFE ADAPTER This adapter cuts cleanly into and through material with minimum deformation of the sample. Requires Fixture Base Table TA-BT-KIT.</p>
TA-CLT001	<p>CAPSULE LOOP TENSILE TEST FIXTURE This fixture is used to measure the force required to split on half of a hard gel capsule. Requires Fixture Base Table TA-BT-KIT.</p>
TA-CSF	<p>CIRCULAR SUPPORT FIXTURE This fixture provides support for round samples and retains any potential fluid expressed during the test. Requires Fixture Table Base TA-BT-KIT.</p>
TA-CTP	<p>COMPRESSION TOP PLATE Rectangular plate 150mm X 100mm, used for compressing large samples. Fixture Base Table TA-BT-KIT is normally used to support sample while testing with this large compression plate.</p>
TA-DE	<p>DOUGH EXTENSIBILITY JIG This fixture is used for holding a sheet of raw dough or flat bread to measure the breaking point of the stretched sample. Consisting of 2 aluminum plates, one plate with 25.4mm hole and the other with 38.1mm hole complete with upper fixing plates to hold disc of flat sample. Used with TA18* and TA43* probes respectively. Requires Fixture Table Base TA-BT-KIT.</p>
TA-DEC	<p>DUAL EXTRUSION CELL The Dual Extrusion Cell is used for either forward or back extrusion of fruit puree, pudding, yogurt or similar products. Test cell is cylinder 40mm in diameter and 50mm depth. Forward extrusion forces a semi-solid sample through an outlet of known geometry. Complete with 4 plungers of 34mm, 36mm, 38mm and 40mm in diameter and interchangeable base plates with apertures of 8mm, 6mm, 4mm, 2mm and one blank. Requires Fixture Base Table TA-BT-KIT.</p>
TA-DGF	<p>DUAL GRIP FIXTURE These are multipurpose general jigs for tensile type testing. The fixtures utilize a universal fitting enabling 360° rotation for comprehensive test configuration. The 25mm wide grips are fitted with rubber inserts to maximize contact adhesion with sample and are capable of holding rectangular samples up to 5mm thick. Each grip clamps from both sides of sample with two opposing thumbscrews. Attaches to slot in CTX base. Does not require any base table.</p>
TA-DSJ	<p>DOUGH STICKINESS JIG This fixture is used for measuring dough stickiness as a standard test; important for processing raw dough. Requires Fixture Base Table TA-BT-KIT and TA3/1000 or TA11/1000* probe.</p>
TA-EP	<p>EYE PENCIL TEST FIXTURE This fixture measures the hardness of cosmetic pencil tips for eye- or lip-ling products and can also be used for artistic type pencil tips. Requires Fixture Base Table TA-BT-KIT.</p>

- TA-FMBRA** **FMBRA STANDARD DOUGH POT SET**
 This set is used for preparing dough samples and measuring dough firmness. The set comprises of two test cells and two plungers: An aeration plunger and a compacting plunger. A known weight of sample is placed in the pot and the aeration plunger is used to remove air pockets through gentle rotation. The dough is then assessed for firmness using a TA41 6mm Ø stainless steel probe. Includes Dough Aerator, Dough Compactor & 2 Containers.
- TA-FSF** **FILM SUPPORT FIXTURE**
 This fixture is used for puncture tests to measure the strength of fine films. Requires Fixture Base Table TA-BT-KIT.
- TA-GPJ** **GENERAL PEELING JIG**
 This fixture measures the adhesive strength needed to remove the lid from a sealed container at 0°, 45°, and 90° angles. Requires Fixture Base Table TA-BT-KIT.
- TA-HCF** **HAIR COMBABILITY TEST FIXTURE**
 This fixture measures the effect of products, such as shampoo and conditioners, on the combability of hair.
- TA-JMPA** **JUNIOR MULTIPLE PROBE ASSEMBLY**
 This multiple probe assembly, consisting of nine 3mm probes and corresponding base plate, is specifically designed to hold nine small samples of irregular geometry, such as peas, corn, nuts or dried fruit. Requires Fixture Base Table TA-BT-KIT.
- TA-KF** **KEIFFER DOUGH AND GLUTEN EXTENSIBILITY FIXTURE**
 This fixture quantifies maximum force and distance needed to break the sample. Requires Fixture Base Table TA-BT-KIT.
- TA-KSC** **KRAMER SHEAR CELL**
 The Kramer Shear Cell follows principles of the Allo-Kramer Shear Press. Test cell (53mm X 57mm X 56mm) has clear Perspex front for viewing test progress. Ten shear cutting blades alternating (65mmL) are loosely suspended from blade holder. Blade holder has quick-release mounting mechanism allowing removal for cleaning without disturbing the alignment. Requires Fixture Base Table TA-BT-KIT.
- TA-LC** **LIPSTICK CANTILEVER TEST FIXTURE**
 This fixture allows imitative tests on lipstick and similar products to quantify the strength of a product. Requires Fixture Base Table TA-BT-KIT.
- TA-LTT** **LOOP TACK TESTER**
 This tester measures the adhesive strength of pressure sensitive tape and stickers according to ASTM D6195. Requires Fixture Base Table TA-BT-KIT.

TA-MA	<p>MUCO ADHESION TEST FIXTURE This fixture quantifies tablet adhesiveness to a mucosal surface by simulating body and temp conditions and force needed to pull tablet away from surface.</p>
TA-MDI	<p>METER DOSE INHALER TEST FIXTURE This fixture measures the push-button force to actuate the inhaler. Requires Fixture Base Table TA-BT-KIT.</p>
TA-MCF	<p>MULTIPLE CHIP FIXTURE This fixture is used for testing the penetration or firmness of multiple chips/ french fries. Requires Fixture Base Table TA-BT-KIT.</p>
TA-MP	<p>MESH PROBE This fixture quantifies the consistency of products such as mayonnaise and yogurt. Requires Fixture Base Table TA-BT-KIT.</p>
TA-MTP	<p>MAGNUS TAYLOR PROBE KIT This probe kit is used for puncture tests to measure the hardness of fresh fruit and vegetables. This kit includes the following probes: Flat End Probe, 3mm TA-MTP-3F; Round End Probe, 3mm TA-MTP-3R; Flat End Probe, 4mm TA-MTP-4F; Round End Probe, 4mm TA-MTP-4R; Flat End Probe, 5mm TA-MTP-5F; Radius End Probe, 5mm TA-MTP-5R; Flat End Probe, 6mm TA-MTP-6F; Radius End Probe, 6mm TA-MTP-6R; Flat End Probe, 7mm TA-MTP-7F; Radius End Probe, 7mm TA-MTP-7R. Requires Fixture Base Table TA-BT-KIT.</p>
TA-NTF	<p>NOODLE TEST FIXTURE This fixture is used to evaluate noodle quality. Requires Fixture Base Table TA-BT-KIT.</p>
TA-OC002	<p>OTTAWA CELL The Ottawa cell follows principles of the Ottawa Test Measurement System (OTMS). Test cell (45mm X 45mm X 55mm) has clear Perspex front for viewing test progress. Corresponding plungers (43mm sq. and 40mm sq.) are used to compress and extrude samples. Complete With 3 Plates (one with pattern of holes 44mm diameter and the other with bars) and 2 Plungers for forward and back extrusion. Requires Fixture Base Table TA-BT-KIT.</p>
TA-PF90	<p>90° PEEL FIXTURE This fixture measures the adhesive strength to pull tape of of a rigid surface using force at a 90° angle. Requires Fixture Base Table TA-BT-KIT.</p>
TA-PFS	<p>PASTA FIRMNESS AND STICKINESS JIG This fixture measures the firmness and stickiness of uncooked pasta. Requires Fixture Base Table TA-BT-KIT.</p>

TA-PFS-C	<p>COOKED PASTA FIRMNESS AND STICKINESS JIG This fixture measures the firmness and stickiness of cooked pasta and like products. Requires Fixture Base Table TA-BT-KIT.</p>
TA-PTF	<p>PIZZA TENSILE FIXTURE This fixture quantifies cooked pizza firmness by measuring the tensile force and deformation distance to break the sample.</p>
TA-RCA	<p>ROLLER CAM ACCESSORY This accessory's grips measure the tensile strength and tear characteristics of material such as polymer films.</p>
TA-RT	<p>RAFT TESTER The Raft Tester looks like a L-hook. It is used in the assessment of the Strength of Alginate Rafts, used in the treatment of gastro-oesophageal reflux. The force required to pull the raft tester up through the raft is recorded as the raft strength (peak Load). Requires Fixture Base Table TA-BT-KIT.</p>
TA-SBA001 & TA-SBA003	<p>SET OF 4 SHEAR BLADES Including Warner Bratzler test jig complete with slotted base. The blade set includes four shear blades either 1mm (001) or 3mm (003). The jig is utilized in the measurement of shearing and cutting forces, as the blades pass through a sample. Requires Fixture Base Table TA-BT-KIT.</p>
TA-SFF	<p>SPAGHETTI FLEXURE FIXTURE This fixture is used to quantify flexure characteristics of uncooked spaghetti and other dry pastas.</p>
TA-SFJ	<p>SLIDING FRICTION JIG This fixture measures the coefficient of friction for packaging materials according to ASTM D1894. Requires Fixture Base Table TA-BT-KIT.</p>
TA-STF	<p>SPREAD TEST FIXTURE This fixture quantifies the force to spread a material on a surface. The Fixture includes one male cone, five female cones and one female cone holder. Requires Fixture Base Table TA-BT-KIT.</p>
TA-STJ	<p>SYRINGE TESTING JIG This fixture is used for measuring the force required to push or pull a syringe plunger. Important to pre-filled syringe market or manufacturers of custom syringe products. Fixture designed to hold syringe barrel while pushing or pulling syringe plunger. A clamping mechanism to hold syringe barrel adjusts to accommodate barrel up to 40mm in diameter. Requires Fixture Base Table TA-BT-KIT.</p>
TA-TCA	<p>TABLET COATING ADHESION FIXTURE This fixture measures the adhesion force of a tablet coating to a tablet. Requires Fixture Base Table TA-BT-KIT.</p>

TA-TEF	TUBE EXTRUSION FIXTURE This fixture measures the force needed to squeeze cream or paste out of a tube. Requires Fixture Base Table TA-BT-KIT.
TA-TPB	THREE POINT BEND TEST FIXTURE Three point bend test fixture is used for fracture tests of brittle materials. Sample supports can be adjusted to provide spacing from 10mm-70mm. Sample supports and identical test blade are 80mm in length with a 1.5mm radius rounded edge. Requires Fixture Base Table TA-BT-KIT.
TA-TRF	TORTILLA ROLL FIXTURE This fixture is used to evaluate changes in corn tortilla texture per AACC technical paper by measuring the force to roll up a tortilla. Requires Fixture Base Table TA-BT-KIT.
TA-TSF	TAPE STICKINESS FIXTURE This fixture measures the adhesive force to pull tape off of a surface. Multiple tape samples can be tested simultaneously for average values. Requires Fixture Base Table TA-BT-KIT.
TA-VBJ	VOLODKEVITCH BITE JAWS Compression test used to simulate the shearing action of the front incisors as they bite through a food item, generating an indication of sample toughness or fibrousness. Consisting of both upper and lower jaws, the compressive movement of the traveling beam imitates the human “biting action”. Requires Fixture Base Table TA-BT-KIT.
TA-WSP	WIRE SHEAR PLATE This fixture is an aluminum plate with aperture to pass wire cutting blade through a sample for shear type testing. Good for products with significant stickiness like cheese or butter. Includes TA53 cutting wire. Requires Fixture Base Table TA-BT-KIT.
TA-WB-PY	WATER JACKET SAMPLE CUP FOR TEMP CONTROL Water jacketed cup assembly with RTD temperature probe and CABLE for temperature control on semi solid samples.

Miscellaneous

TA-RT-5	T-Bolt (2)
TA-RT-3	Thumbnut (2)
TA-TBLT	Table Bolt Nut
TA-BT-5	Base Table Insert for TA-BT-KIT
TA51	M6 to M3 Probe Adapter
TA52-4	Packet of 5 Blades for TA52
TA-LVL	Bubble Level

A-3 Calibration Accessories

- TA-CW-100C CALIBRATION WEIGHT SET, 100g WITH CASE & CERTIFICATE**
Set of weights (total mass 100g) to be used to check calibration of the 100g Texture Analyzer. Includes verification certificate traceable to NIST standards.
- TA-CW-1000C CALIBRATION WEIGHT SET, 1000g WITH CASE & CERTIFICATE**
Set of weights (total mass 1000g) to be used to check calibration of the 1000g Texture Analyzer. Includes verification certificate traceable to NIST standards.
- TA-CW-1500C CALIBRATION WEIGHT SET, 1500g WITH CASE & CERTIFICATE**
Set of weights (total mass 1500g) to be used to check calibration of the 1500g CTX Texture Analyzer. Includes verification certificate traceable to NIST standards.
- TA-CW-4500C CALIBRATION WEIGHT SET, 4500g WITH CASE & CERTIFICATE**
Set of weights (total mass 4500g) to be used to check calibration of the 4500g CTX Texture Analyzer. Includes verification certificate traceable to NIST standards. To be used with 5000g.
- TA-CW-10KGC CALIBRATION WEIGHT SET, 10kg WITH CASE & CERTIFICATE**
Set of weights (total mass 10kg) to be used to check calibration of the 10kg CTX Texture Analyzer. Includes verification certificate traceable to NIST standards.
- TIA-8013 HANGER MOUNTING RING**
Used to hang calibration weights. Included with each weight set. Replacements may be ordered with this number. Included with all weight sets up to 10kg.
- TA-CW-2550KGC CALIBRATION WEIGHT SET, 10kg WITH CERTIFICATE**
Set of two 5kg plates (total mass 10kg) to be used to check calibration of 25kg, 50kg and 100kg Texture Analyzers. Includes verification certificate traceable to NIST standards, mounting ring and hanger (TIA-8021Y).
- TA-CW-5000C 5kg CERTIFIED MASS**
Additional 5kg plates to be used with TA-CW-2550KGC weight set. Order as many as needed to check calibration up to load cell maximum.
- TIA-8021Y MOUNTING RING AND HANGER**
Used for stacking TA-CW-5000C calibration weights for checking calibration of 25kg and 50kg CTX Texture Analyzers. Included in TA-CW-2550KGC.
- CCSCTX Calibration & Certification for CTX**

A-4 Gelatin Accessories

TA-GBB-2 BROOKFIELD GELATIN BLOOM BOTTLE KIT (12 pcs.)
One dozen Brookfield gelatin bloom sample bottles that hold 120ml volume and includes TA-SBS stoppers.

GELATIN BATH PREPARATION SYSTEM **Gelatin Preparation Bath System**

TC-450MX (qty 2) and TC-351 (qty 1)
System is used by attaching TC-351 to one TC-450MX bath set to 10°C. Second TC-450MX bath is set to 60°C providing rapid transfer between the thermal environments necessary for conditioning gelatin for Bloom testing. Each bath has 29L reservoir and capacity for twelve (12) gelatin jars and a removable rack for easy handling. 21L of water is required for proper fluid level with rack and 12 bloom jars.

CT3-CS-100 BLOOM TEST STRIP
For use with 100g load cell to check load calibration.

CT3-CS-1000 BLOOM TEST STRIP
For use with 1000g & 1500g load cells to check load calibration.

Appendix B - Troubleshooting

If no power to the instrument:

Check:

- User replaceable fuses: two (2) fuses, 4 amp, 5 x 20 mm, time-lag located behind removable red color panel just above switch.
- Fuses located within power entry module on the rear of the instrument.
- If the fuses blow continually, serious damage to the instrument could result. Contact repair services immediately.

Probe won't attach:

- Check the thread on probe and probe shaft - remove any dirt.

Rotary Base table won't move:

- Ensure the locking knob is loose.
- Ensure the fine adjust nut is loose.

Rotary Base table will not travel to the lowest position:

- Loosen the fine adjust nut and rotate base table.
- Locate the table in center of T-slot.

Instrument is unsteady:

- Ensure that the bench top is stable.
- Adjust the CTX feet.

Probe doesn't move when start is pressed:

- Ensure the reset button is not pressed in (rotate clockwise).
- Ensure the test mode is not in Static Load.
- Ensure the probe is not in contact with sample (or base table).

Appendix C - Online Help and Additional Resources

www.brookfieldengineering.com

The Brookfield website is a good resource for additional and self-help whenever you need it. Our website offers a selection of “how-to” videos, application notes, conversion tables, instructional manuals, material safety data sheets, calibration templates and other technical resources.

www.youtube.com/user/BrookfieldEng

Brookfield has its own YouTube channel. Product and Application Videos can be found here.

Article Reprints

Available in Print Only

- Brookfield has an extensive library of published articles relating to viscosity, texture and powder testing. Due to copyright restrictions, these articles cannot be emailed. Please request your hard copy of articles by calling our customer service department directly or by emailing: MA-MID.sales@ametek.com.

Available Online

- Brookfield has a growing number of published articles that can be downloaded directly from the Brookfield website. These articles can be found on our main site by following this path: www.brookfieldengineering.com/learning-center/articles-and-technical-papers

Training/Courses

Whether it is instrument-specific courses, training to help you better prepare for auditing concerns, or just a better understanding of your methods, who better to learn from than the worldwide leaders of viscosity measuring equipment? Visit our [Services](#) section on our website to learn more about training.

Appendix D - Warranty and Repair Service

Brookfield Texture Analyzers are guaranteed for one year from date of purchase against defects in materials and workmanship. The Texture Analyzer must be returned to **AMETEK Brookfield** or to the authorized dealer from whom it was purchased for a warranty evaluation. Transportation is at the purchaser's expense. If returning to Brookfield, please contact us or go online for a return authorization number prior to shipping. Failure to do so will result in a longer repair time.

For repair or service in the United States return to:

AMETEK Brookfield
11 Commerce Boulevard
Middleboro, MA 02346
U.S.A.

Telephone: (508) 946-6200 FAX: (508) 923-5009
www.brookfieldengineering.com

For repair or service outside the United States, consult AMETEK Brookfield or the dealer from whom you purchased the instrument.

For repair or service in the United Kingdom return to:

AMETEK (GB) Limited
Brookfield Technical Centre
Stadium Way
Harlow, Essex, CM19 5GX
England

Telephone: (44) 27/9451774 FAX: (44) 27/9451775
www.brookfieldengineering.uk

For repair or service in Germany return to:

AMETEK GmbH
Oberweyerer Straße
Hadamar-Steinbach, 65589
Deutschland

Telephone: (49) 6433/9145-0 FAX: (49) 6433/9145-45
www.brookfieldengineering.de

For repair or service in China return to:

AMETEK Commercial Enterprise (Shanghai) Co., Ltd
Room 810 Dongbao Plaza, No. 767 East
Dongfeng Road, Guangzhou, 510600
China

Telephone: (86) 20/3760-0548 FAX: (86) 20/3760-0548
www.brookfieldengineering.cn

On-site service at your facility is also available from AMETEK Brookfield. Please contact our Service Department in the United States, United Kingdom, Germany or China for details.